

ARROW TUNING AND MAINTENANCE GUIDE



The Complete Archer's Resource

2nd Edition

Tuning

This section includes step-by-step tuning procedures for obtaining optimum performance and accuracy from your bow and arrow setup. Also included are equipment setup tips, and suggested solutions to most bow tuning problems.

Subject	Page
Preliminary Bow Setup	1
Standard Tuning Methods	
Bare Shaft Planing Test	4
Paper Tuning Arrow Test	6
Short Distance Fine Tuning Test	8
Trouble-Shooting Arrow Groups	8
Bow & Arrow Adjustments	10
Broadhead Tuning	11
Fine Tuning	12
Micro Tuning	14

Maintenance & Assembly

This section provides instructions for properly cutting shafts and installing components. Arrow maintenance procedures are also included.

Subject	Page
Measuring and Cutting Shafts	15
Aluminum Shaft Component Installation	18
Aluminum/Carbon Component Installation	20
Carbon ICS Component Installation	23
External Component Installation	24
Installing Nock Systems	26
Additional Information	30

INTRODUCTION TO TUNING

Successful tuning can only be achieved by using a properly spined arrow shaft. Initially, it is best to start with a shaft recommended by one of Easton's Arrow Shaft Selection Charts or by one of Easton's computer selection programs, the Arrow Flight Simulator or Shaft Selector "Plus." Final verification is achieved during the tuning process. Any problems due to an improperly spined shaft will become evident during tuning. Before tuning be sure that shafts are straight, are properly fletched, and have perfectly aligned nocks (see pages 15 thru 30).

Choose Your Shooting Style.

Tuning procedures for the three most popular shooting setups are described and abbreviated throughout the manual as follows:

- ◆ recurve bows, using finger release (RF)
- ◆ compound bows, using finger release (CF)
- ◆ compound bows, using a release aid (CR)

You will notice that some of the techniques of bow tuning apply to all types of bow setups and others apply to just one or two types. When separate tuning procedures are required for specific setups, find your setup within the topic and follow those specialized instructions.

Install All Accessories

Before you start any bow tuning procedures, be sure to install all accessories on your bow, i.e., the correct bowstring, bow sight, stabilizers, arrow rest, cushion plunger, etc. In other words, install all the items you intend to use when shooting. Any adjustments made to the bow or changes in bow components can affect the tune of your equipment. When tuning, it is very important to change only one variable at a time!

PRELIMINARY BOW SETUP

The first phase in achieving well tuned equipment is good preliminary equipment setup. If the initial setup is done correctly, bow tuning can be an easy process. By following the bow setup guidelines in the initial preparation of your equipment, you can eliminate most or all of the possible disturbances which cause tuning problems, including false tuning indicators. A false tuning indicator would be having a high nocking point indication when the problem is actually poor clearance.

Install the Nocking Point

Install a moveable nocking point on the bowstring. Clamp-on types are ideal. Initially, position the nocking point on the bowstring about 1/2" (1.3 cm) above square for RF and CF and approximately 1/4" above square (0.63 cm) for CR. See Fig. 1.

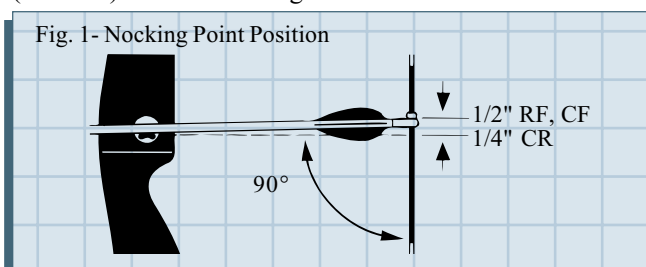

Fig. 1- Nocking Point Position

Find the Limb Centers

In order to have a reference point from which to adjust the arrow's left/right position on the bow, it is necessary to find and mark the exact center of the limbs on a recurve bow, or what is termed the "balanced limb center" on a compound bow.

Recurve Bows

To find the limb center for recurve bows, place a piece of masking tape across the inside of each limb a few inches from the riser. With an ink pen, make a small vertical mark on the tape in the exact center of each limb.

Compound Bows

To find the balanced limb center location for the preliminary setup of your compound bow, place a piece of masking tape across the inside of each limb a few inches from the riser. Accurately measure the width of the limb (at the tape) and place a very small pen (or pencil) mark on the tape in the exact center of each limb. Next, measure $\frac{3}{16}$ " (4.8 mm) to the left of the mark (for right-handed archers) and make a larger vertical mark on the tape. (Left-handed archers place a larger mark $\frac{3}{16}$ " (4.8 mm) to the right of the limb center mark.) This second mark will be used for arrow centering. (See Fig. 2.) This procedure is done to compensate for the amount the eccentric wheel or cam is offset from the actual center of the limb. The $\frac{3}{16}$ " (4.8 mm) measurement is an average "offset" difference for most compound bows and does not need to be a precise measurement in the preliminary setup stage, as you will locate the true balanced limb center when performing the fine tuning procedures.

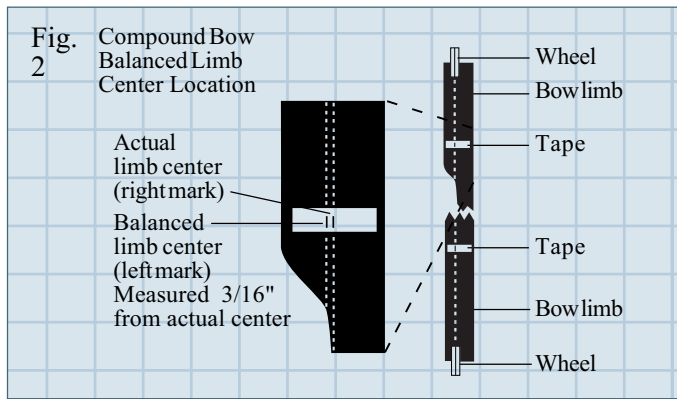

"Centering" the Arrow

The objective of arrow centering is to have the arrow leave the "theoretical" or "balanced" limb center of the bow. In actuality, it's the two nodes of the arrow shaft that should leave the center of the bow in direct alignment to the target. Releasing the string with fingers creates a horizontal bending motion within the arrow. Releasing the string with a release aid causes a slight up/down bending motion instead. Because of this, the arrows must be positioned differently for each style of release. (See Node Alignment diagram to the right). A description of these position adjustments follows.

Aligning the Nodes

Fig. 3 - Nodes

Arrow Nodes - As the arrow oscillates, the nodes remain in direct alignment to the target. This diagram clearly illustrates the front and rear node positions of the arrow. The front node is usually closer to the front end of the arrow than the rear node is to the nock end. This is due to the mass weight of the point—nodes will always be located closer to the heavier mass.

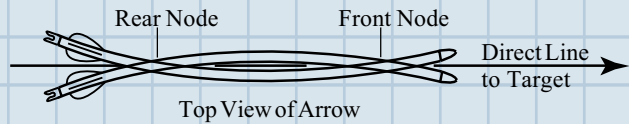

Fig. 4

Finger Release (RF, CF)

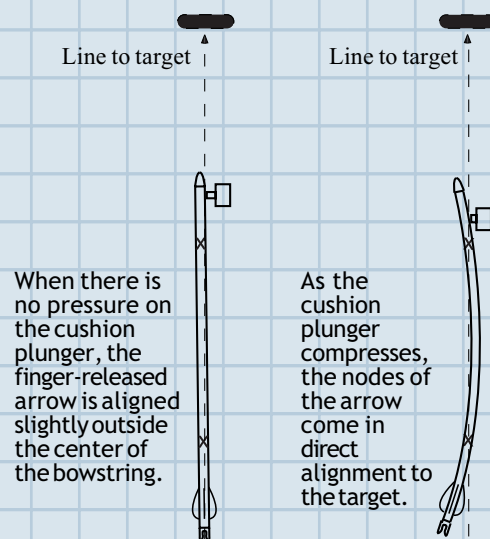

Fig. 5

Compound Mechanical Release (CR)

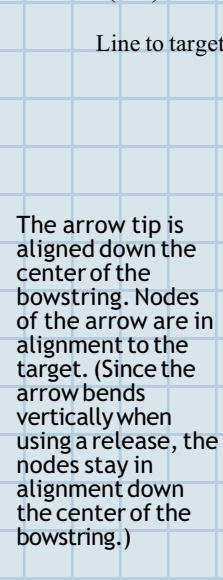
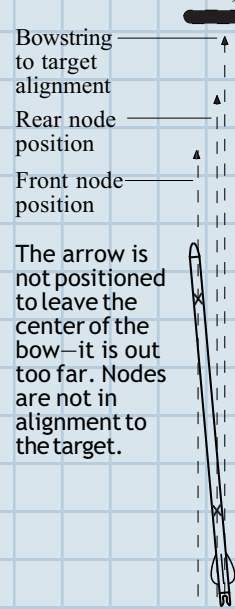

Fig. 6

Misaligned Arrow RF, CF, CR (Incorrect Arrow Rest Position)



The arrow tip is aligned down the center of the bowstring. Nodes of the arrow are in alignment to the target. (Since the arrow bends vertically when using a release, the nodes stay in alignment down the center of the bowstring.)

The arrow is not positioned to leave the center of the bow—it is out too far. Nodes are not in alignment to the target.

Adjust the Arrow's Left/Right Position

Adjust the horizontal (in/out) position of the cushion plunger or arrow rest assembly so that the tip (center) of the arrow point is correctly aligned with the type of equipment you shoot.

With Finger Release (RF, CF)

 Align the "tip" of the arrow point $\frac{1}{16}$ " to $\frac{1}{8}$ " (1.6-3.2 mm) or less outside the bowstring with the bowstring properly centered according to Fig. 7. The arrow tip is placed slightly outside the string to provide compensation for the amount the cushion plunger or side loading device compresses into the bow when the arrow is released. See Fig. 4.

With a finger release, the arrow bends horizontally, first bending in toward the bow, then bending away from the bow, which causes the arrow shaft to leave the arrow rest. In the next bending sequence, the arrow nock disengages from the bowstring. The arrow is then on its way, freely oscillating all the way to the target. The amount of oscillation decreases as the arrow travels farther from the bow.

With Mechanical Release (CR)

 Align the "tip" of the arrow point down the center of the bowstring. See Fig. 5. The center line (axis) of the arrow must start out in a direct line with the bowstring when the bowstring is aligned to the balanced limb center. See Fig. 7.

When using a release, the arrow most often bends vertically, rather than horizontally. Therefore, there is no need to compensate for any inward compression of the arrow rest or cushion plunger. Follow the bow tuning methods in the Fine Tuning and Micro Tuning sections on pages 12-14 to find the best in/out position for your arrow shaft, which allows the arrow nodes to be in direct alignment to the target. The diagrams in Fig. 7 indicate the correct in/out arrow position for your shooting style.

Fig. 7 - Arrow Centering

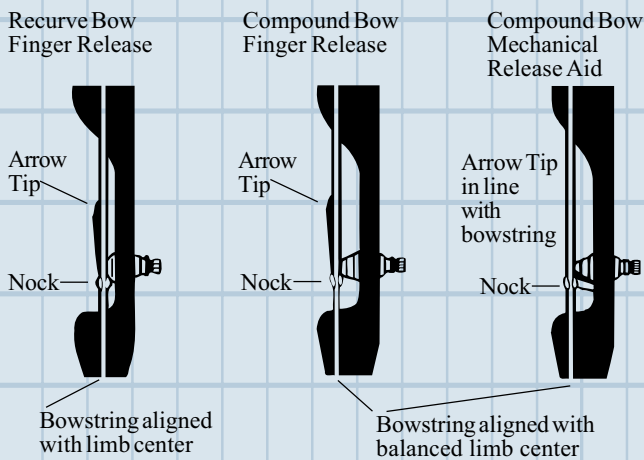

Adjust the Arrow Rest

(recurve and compound)

The arrow rest support arm position is critical to achieving good arrow clearance.

With Finger Release (RF, CF)

 Most Flipper/Rest setups have an adjustable arm for the arrow rest. If this adjustment is available on the rest you're using, the arrow rest support arm should be adjusted so that it is not visible past the outside of the arrow shaft when observed from an overhead view. See Fig. 8.

With Mechanical Release (CR)

 On launcher type rests, commonly used on compound bows with release aids, be sure that the arrow support arm is narrow enough to allow the two lower vanes to pass over the rest without making contact. (See the Fig. 9.) This is very important for archers using release aids because the arrow is most often supported on the rest for its full length of forward travel. For the smaller diameter aluminum/carbon or carbon shafts with less space between vanes, it may be necessary to significantly reduce the width of the launcher blade.

Fig. 8

Arrow Rest - Overhead View (RF, CF)

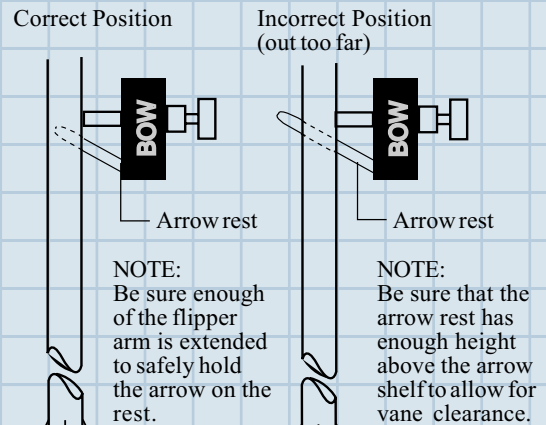
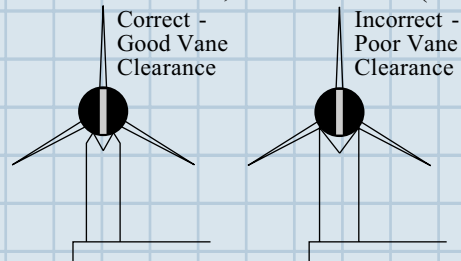

Fig. 9

Arrow Rest - Back View, Vane Clearance (CR)



Adjusting for Outsert Components (CR)

When using carbon arrow shafts which have externally fitted nocks, it may be necessary to adjust your nocking point up slightly to allow the nock to clear the arrow rest. The nock diameter is significantly larger than the shaft diameter on these arrows. A slightly higher nocking point lifts the arrow off of the arrow rest and keeps the nock from coming in contact with it, eliminating a potential clearance problem.

Riser-Mounted Clickers (rf, cf)

For clicker shooters, be sure that the arrow is well supported on the rest and not held in place by the tension of the clicker only. It is important to draw the bow a few times without the clicker to make sure the arrow can be drawn and let down without the arrow falling off the arrow rest.

Align the Bow-sight Pin

Initially, set the sight pin on your bow sight over the centerline of the arrow shaft.

Set the Cushion Plunger

Not every type of bow setup uses a cushion plunger. Some archers use rests without a cushion plunger. For example, many tournament archers use a Springy™ rest, and some traditional archers use other styles of arrow rests that do not have side pressure tension adjustments. If your setup incorporates a cushion plunger, start with the spring tension set at medium.

Set the Brace Height

(Recurve bows)

Start with the brace height at the lower end of the manufacturer’s recommendation or use the following chart. To locate the optimum brace height for your particular bow, “twist up” the bowstring to make it shorter. This raises the brace height.

BOWLENGTH	BEGINNINGBRACEHEIGHT
64"	8 1/4" - 8 1/2" (21.0 cm - 21.6 cm)
66"	8 3/8" - 8 5/8" (21.3 cm - 21.9 cm)
68"	8 1/2" - 8 3/4" (21.6 cm - 22.2 cm)
70"	8 5/8" - 8 7/8" (21.7 cm - 22.5 cm)

All bows are different, even ones of the same make and model. Therefore, it is important to locate a brace height that fits your particular bow and shooting style. Shoot a few arrows at the suggested beginning brace height, then unstring the bow, add 3-4 twists to the bowstring and shoot again. Continue this process until the bow feels smoothest and quietest when shooting.

If the bowstring is too short to allow a brace height at the lower setting, you may wish to use a slightly longer string. If the string is too long to allow a higher brace height (and starts to knot-up from too many twists), you may wish to try a slightly shorter bowstring. There are many custom bowstring makers who produce strings to your exact

specifications including length, type of material, type and color of serving, etc.

The brace height determines the specific point at which the arrow separates from the bowstring and the amount of bend the arrow has when the separation occurs. The best brace height for your recurve or compound bow is one that allows the most compatible launch position for the arrow at the end of the bow’s “power stroke.” Locating the best brace height for your bow can significantly improve arrow grouping and shooting consistency.

Set the Brace Height

(Compound bows)

Brace height is set by the compound bow manufacturer. Sometimes changing the brace height to a slightly higher or lower position will improve arrow flight and grouping. This can be accomplished by changing the length of the string, as described previously for recurve bows. Remember, however, that changing the brace height of a compound bow affects the draw weight and draw length of the bow.

Nock-to-Bowstring Tension

The nock tension (“snap fit”) necessary to separate the nock from the bowstring serving can be very critical, especially on light draw-weight bows (30 lbs. and under). Nock tension should be tight enough so the arrow can easily support its own weight when the arrow is hanging vertically on the bowstring (nock against the nocking point). To check this, hang your arrow vertically from the bowstring, and give the string a sharp tap with your finger on the serving about 1-2" (2.5-5 cm) from the arrow nock. The arrow should separate from the string. If it does not, the nock is probably too tight for most target archery. For hunting, a slightly tighter nock-to-bowstring fit is often preferred.

STANDARD TUNING METHODS

Now that you have completed the preliminary adjustments you can start the tuning process. Four methods of bow tuning are described (pp. 4 thru 14)—the Bare Shaft Planing Test, the Paper Tuning Arrow Test, Short Distance Tuning, and Broadhead Tuning.

Bare Shaft Planing Test

(Finger release - RF, CF)

In addition to tuning, the bare shaft test is also useful for determining if the correct shaft has been selected. If the left/right adjustments outlined under “Fishtailing” do not cause the unfletched shafts to group with or very near the fletched shafts, then a weaker or stiffer spined shaft (based on where the arrows have impacted) must be selected. Arrows that do not fly well and do not group tightly are usually affected by one or more of the following problems:

1. They may PORPOISE in flight.
2. They may FISHTAIL in flight.
3. They may not CLEAR the bow properly as the arrow leaves the bowstring.
4. They may MINNOW in flight (a specific type of clearance problem).

Porpoising

It is important to correct for Porpoising first. If the arrow leaves the bowstring with the nock too high or too low, a motion known as Porpoising occurs. Porpoising is caused by an incorrect nocking point location. Use the Bare Shaft Planing Test to find the correct nocking point location. Shoot at least three fletched shafts at a distance of 15 to 20 yards (or meters). Then shoot two identically-aimed unfletched shafts. Once you get the bare shafts to impact close to the fletched arrows at 20 yards (or meters), you may want to try shooting 25-30 yards (or meters) for a finer tuning indication.

If the unfletched shafts impact above the identically-aimed fletched shafts, move the nocking point up on the bowstring until both fletched and unfletched shafts strike at the same elevation. See Fig. 10.

If the unfletched shafts impact below the identically-aimed fletched shafts, move the nocking point down on the bowstring until the unfletched shafts hit at the same elevation or slightly lower than the fletched shafts.*

To assure you have eliminated Porpoising, repeat the test, shooting first the fletched, then the unfletched shafts, and make adjustments to the nocking point until both fletched and unfletched shafts impact at the same elevation.

Fig. 10
Porpoising

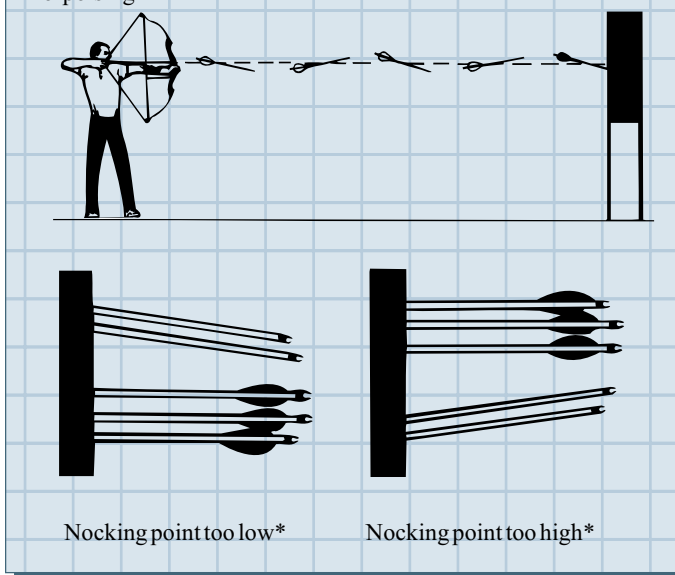

* It is sometimes desirable to have the bare shaft impact just slightly below the identically-aimed fletched shafts. Bare shafts that impact above identically-aimed fletched shafts indicate a low nocking point. If the nocking point is too low, it may force the arrow fletching down into the arrow rest, creating Clearance problems.

Fishtailing

If the arrow leaves the bow with the nock end leaning to one side or the other, Fishtailing occurs. The nock end of the arrow will appear to move from side to side as the arrow follows its flight path. See Fig. 11.

Use the Bare Shaft Planing Test to correct Fishtailing. Shoot three fletched shafts at a distance of 15 to 20 yards (meters), then shoot two identically-aimed, unfletched shafts.

If the unfletched shafts impact left (stiff) of the identically-aimed, fletched shafts, as seen in Fig. 11 (for a right-handed archer), either decrease the spring tension on the cushion plunger, increase bow weight slightly (if your bow weight is adjustable), or increase arrow point weight.

If the unfletched shafts impact right (weak) of the identically-aimed, fletched shafts, as seen in Fig. 11 (for a right-handed archer), increase the spring tension on the cushion plunger, decrease bow weight slightly (if your bow weight is adjustable), or decrease arrow point weight.

Your equipment is basically tuned when the bare shafts and fletched shafts impact at the same or very near the same location. Once you have completed the finer tuning methods listed for Fine Tuning and Micro Tuning on pages 12-14, do not be surprised if the bare shaft impact changes. It is common on a well-tuned bow to have the bare shaft impact a little low and slightly stiff (to the left of the fletched shafts for a right-handed archer). Occasionally, a good tune may be achieved with the bare shaft impacting slightly weak (to the right of the fletched shafts for right-handed archers), but this is less common.

When correcting Fishtailing using the Bare Shaft Planing Test, you may have a problem adjusting the unfletched shaft's impact to that of the fletched shaft. Your arrows might be too weak (the unfletched shaft impacts to the right of the fletched shaft for right-handed archers) or too stiff (the unfletched shaft impacts to the left of the fletched shaft for right-handed archers). If, after completing this test, the bare shaft impact is more than 6 inches (15 cm) to the right (weak) or left (stiff) of the fletched shafts at 20 yards (18 m), you will need to make some modifications to the equipment to achieve a better tune. Follow the suggestions on how to better match the arrow to your bow in the "Adjustments Within the Bow and Arrow System" section on page 10.

Clearance

Proper clearance is absolutely essential for optimum grouping, consistency and accuracy. This is especially true with ultra-light weight arrows like the UltraLite aluminum, the A/C/E and A/C/C HyperSpeed shafts.

After you have performed the Bare Shaft Planing or Paper Tuning Arrow Test, it is a good idea to check for adequate clearance. To check for clearance, use dry powder foot spray, dry deodorant spray or similar product, applied to the last quarter of the arrow shaft, fletching, arrow rest assembly and sight window near the arrow rest. Do not disturb the powder sprayed on the arrow and

Fig. 11
Fishtailing

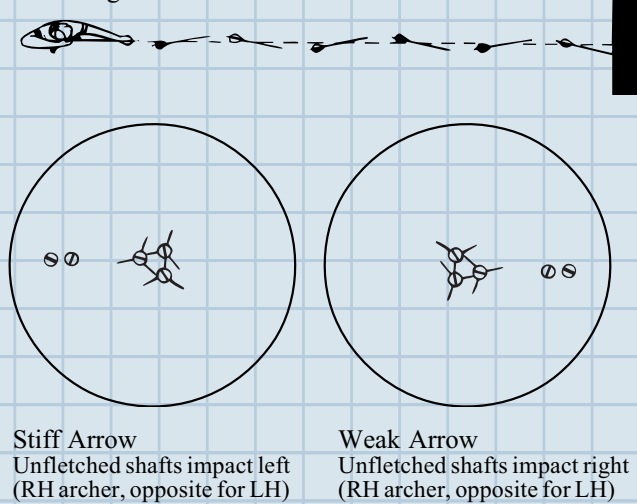
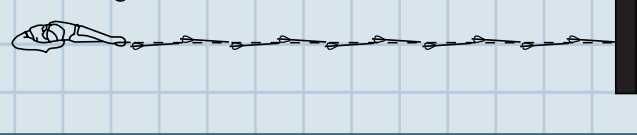

Fig. 12
Minnowing



bow while preparing to shoot. The arrow should be shot into a firm target so that it will not penetrate to the fletching.

If you are not achieving good arrow clearance, and the arrow fletching and bow make contact, optimum grouping cannot be achieved. By examining the areas where the dry powder spray is scraped off, the nature of any interference can be determined, and the position of the fletching as the arrow leaves the bow can be identified.

Easton has introduced a new term indicating clearance problems called Minnowing. Like Fishtailing or Porpoising, Minnowing indicates a specific arrow flight disturbance. Minnowing will appear to look much like Fishtailing except that the tail of the arrow appears to move from side to side more quickly, and the amount of side swing is usually much less than in Fishtailing. (See Fig. 12.) Minnowing indicates inadequate clearance and is caused by the rear portion of the arrow (usually fletching) contacting the arrow rest assembly.

Correcting Clearance Problems

The following procedures can help you correct clearance problems that cause Minnowing:

1. If the arrow fletching is hitting the arrow rest, try rotating your arrow nock 1/32 of a turn. Continue rotating the nock in 1/32-turn increments until clearance is achieved.

2. Make sure your arrow rest support arm does not protrude past the outside of the arrow shaft when the arrow is resting on the support arm and is lying against the cushion plunger or side loading device. See Fig. 8.
3. Choose a lower profile fletching.
4. Follow the procedures for Tuning Adjustments within the Bow and Arrow System on page 10 for equipment modifications to achieve a better tune.
5. Move the cushion plunger or side loading device slightly out from the bow to help increase clearance if the other tuning modifications have no effect.

Paper Tuning Arrow Test

(Recurve or compound - RF, CF, CR)

Archers using mechanical release aids (CR) should review the following reminder notes before starting the Paper Tuning Test.

1. Align the arrow down the center of the bowstring with the tip of the arrow point correctly positioned as indicated in Fig. 7, page 3.
2. Initially position the sight pin over the centerline of the arrow.
3. When using a release aid the arrow normally bends more vertically than horizontally, so good clearance is essential. Usually, the entire arrow contacts the rest when it is shot and the fletching must be positioned to clear the rest.

“SHOOT-THROUGH” RESTS - It may be necessary to adjust the width of the arrow rest support arm(s) so the fletching will pass cleanly over or through.

“SHOOT-AROUND” RESTS - Vane-to-nock indexing is very important and should be adjusted to achieve maximum clearance.

The Paper Tuning Arrow Test is the most commonly used bow tuning test for archers using compound bows with release aids. This test also works well for finger release:

1. Firmly attach a sheet of paper to a picture frame type rack approximately 24" X 24" (60 x 60 cm).
2. Position the center of the paper about shoulder height with a target mat about six feet behind the paper to stop the arrows.
3. Stand approximately 4 to 6 feet (7.8-1.5 m) from the paper.
4. Shoot a fletched arrow through the center of the paper with the arrow at shoulder height (parallel to the floor).
5. Observe how the paper is torn.

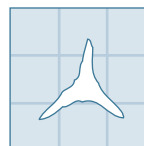

This tear indicates good arrow flight. The point and fletching enter the same hole.

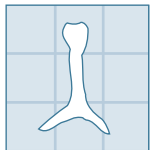

This tear indicates a low nocking point. To correct, raise the nocking point 1/16" (1.6 mm) at a time and repeat the procedure until the low vertical tear is eliminated.

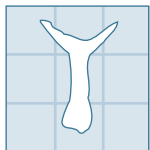

This tear indicates a high nocking point, clearance problem, or a very weak arrow if you are using a release aid. To correct, lower the nocking point 1/16" (1.6 mm) at a time until the high tear is eliminated. If, after moving the nocking point a few times, the problem is unchanged, the disturbance is most likely caused by a lack of clearance or by an arrow which is too weak (if using a release aid). To identify a clearance problem, check to see if the arrow fletching is hitting the arrow rest. (See "Clearance" on page 5.)

CR - If no clearance problem exists and you are using a mechanical release, try:

1. A more flexible arrow rest blade if using a launcher type rest or reduce downward spring tension on adjustable tension launcher rests.
2. Decreasing peak bow weight if there is an indication the arrow spine is too weak.
3. Reducing the amount the shaft overhangs the contact point on the arrow rest.
4. Choosing a stiffer arrow shaft.

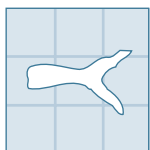

This tear indicates a stiff arrow reaction for right-handed archers using finger release (RF, CF). Left-handed finger release archers will have an opposite pattern. This is an uncommon tear for right-handed compound archers using a mechanical release (CR). However, it can occur and generally indicates that the arrow rest position is too far to the right or that there is possible vane contact on the inside of the launcher rest.

Finger Release (RF, CF) To correct:

1. Increase bow weight/peak bow weight.
2. Use a heavier arrow point and/or insert combination.
3. Use a lighter bowstring (less strands or lighter material, like Fast Flight®).
4. Use a weaker spine arrow.
5. Decrease cushion plunger tension or use a weaker spring on "shoot around" rests.
6. CF only - Move the arrow rest slightly in toward the bow.

Mechanical Release Aid (CR) To correct:

1. Move the arrow rest to the left. Continue moving the rest to the left in small increments until the right tear is eliminated.
2. Make sure the arrow has adequate clearance past the cable guard and cables.

3. Make sure the bow hand is well relaxed to eliminate excessive bow hand torque.

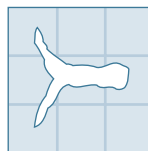

This tear indicates a weak arrow reaction or clearance problem for right-handed finger release (RF, CF) archers. Left-handed finger release archers will have the opposite pattern. For right-handed compound archers using mechanical releases (CR), the left tear is common and usually indicates a weak arrow reaction and/or clearance problem. If a high-left tear exists, (see next tear illustration) make sure you correct the nocking point first before proceeding further.

Finger Release (RF, CF) To correct:

1. Check for Clearance (See page 5).
2. Decrease bow weight/peak bow weight.
3. Use a lighter arrow point and/or insert combination.
4. Use a heavier bowstring (more strands or heavier material).
5. Use a stiffer spine arrow.
6. Increase cushion plunger tension or use a stiffer spring on "shoot around" rests.
7. CF only - Move the arrow rest slightly out, away from the bow.

Mechanical Release Aid (CR) To correct:

1. Move the arrow rest to the right. Continue to move the rest to the right in small increments until the left tear is eliminated.
2. Make sure the bow hand is well relaxed to eliminate excessive bow hand torque.
3. Decrease peak bow weight.
4. Choose a stiffer spine arrow.

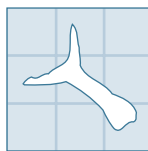

This tear shows a combination of more than one flight disturbance. Use the procedures that apply to the tear pattern for your style of shooting, and combine the recommendations, correcting the vertical pattern (nocking point) first, then the horizontal. If you experience a tuning problem (especially with the nocking point location) and are unable to correct a high/low tear in the paper, have your local pro shop check the "timing" (roll-over) of your eccentric wheels or cams.

For archers using release aids, it may, in some cases, be necessary to apply adjustments opposite from those described. The type of arrow rest and release aid combination used can alter the dynamic flex of the arrow to produce tear patterns contrary to those indicated (although it is uncommon).

Once you have achieved a good tune at 4 to 6 feet (1.2-1.8 m), move back 6 feet (1.8 m) more and continue to shoot through the paper. This ensures that the tune is correct and that the arrow was not just in a recovery position when it passed through the paper at the first distance.

SHORT DISTANCE TUNING

(Recurve and compound - RF, CF, CR)

Many times it is not possible to shoot long distances when your equipment needs to be tuned. The following method results in a very good equipment tune at short distances. Use this tuning method after you have completed one of the basic bow-tuning methods—either the Bare Shaft Planing or Paper Tuning Arrow Test.

Start at approximately 12 to 15 yards (meters) from the target. Use a 40 cm or 60 cm target face and place it with the face side in so you are shooting at a plain white target.

Up-Down Impact

Using fletched arrows only, shoot approximately 6 to 8 arrows along the top edge of the target face. This step determines if your nocking point is correct. See Fig. 13.

Normally, small tuning problems show up at close range, because the arrow has its maximum vibration at short distance. This test assists you in identifying these arrow flight problems and makes it possible to make finer adjustments than with the previous tuning procedures.

If you are unable to consistently hit the top edge of the target face, there is probably a small tuning disturbance in the equipment. To correct, make a $\frac{1}{32}$ " (.8 mm) nocking point adjustment either up or down and shoot again. Continue making nocking point adjustments in $\frac{1}{32}$ " (.8 mm) increments (no more than $\frac{1}{32}$ " (.8 mm) at a time).

If your arrows are hitting the top edge of the paper more consistently and you are achieving a straight, horizontal line of arrows across the top of the paper, you are correcting the disturbance. If the horizontal line of arrow impact is widening, go back to your original nocking point position and start making $\frac{1}{32}$ " (.8 mm) nocking point adjustments in the opposite direction. This will provide you with the correct nocking point position.

Left-Right Impact

Once you have achieved the straightest horizontal line of arrows that your ability will allow, you are ready to tune for left/right arrow impact. Shoot 6 to 8 arrows at the left edge of the paper in a vertical line. See Fig. 14.

To improve the left/right impact for CR and CF archers, move the in/out position of your arrow rest. This is done to compensate for the effect of the eccentric wheel. The offset of the eccentric wheel on compound bows does not always compensate for the degree of natural torque generated in the bow. The wheel often torques or leans over slightly as it reaches the full draw position. This is common and is nothing to be concerned about. At full draw, the "limb center" you started with in the preliminary setup may not really be the true balanced center. Therefore, through some trial and error, you must locate the best in/out position for the arrow to obtain maximum accuracy.

Make a $\frac{1}{32}$ " (.8 mm) adjustment either in or out and shoot again. Continue making $\frac{1}{32}$ " (.8 mm) adjustments

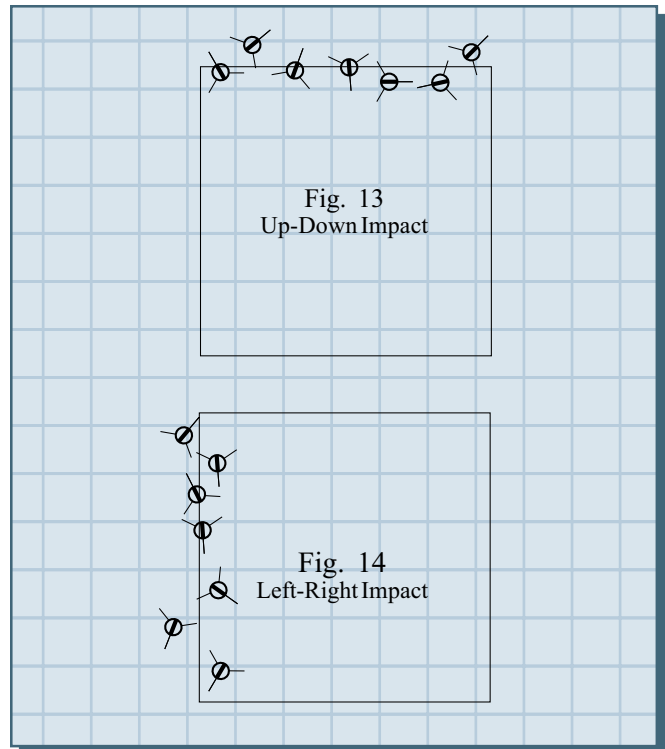

until you achieve the best possible vertical impact line of arrows. If the vertical line widens, go back to your original arrow rest position and move it $\frac{1}{32}$ " (.8 mm) in the opposite direction. If the vertical line narrows, continue $\frac{1}{32}$ " (.8 mm) adjustments in that direction until you achieve the straightest line possible.

CF archers using cushion plungers should make the necessary arrow rest adjustments and then try a second tuning adjustment, the cushion plunger spring tension. Increase or decrease spring tension $\frac{1}{8}$ of a turn at a time. Again, if the vertical line becomes wider, return to the original spring tension setting and make $\frac{1}{8}$ turn adjustments in the opposite direction until you achieve a narrow vertical impact line.

RF archers should make cushion plunger spring tension adjustments only, increasing or decreasing the spring tension $\frac{1}{8}$ -turn at a time. If the vertical line becomes wider, return to the original spring tension setting and make $\frac{1}{8}$ -turn adjustments in the opposite direction until you achieve a narrow vertical impact line. Do not move the in/out position of your arrow! The in/out position of your arrow to the centerline of the bow has already been established in the preliminary equipment setup.

TROUBLE-SHOOTING ARROW GROUPS

You may have heard people say, "If your arrows group well at 20 yards, they will group at any distance," or, "If your arrows group at long distances, they will group at short distances." In some cases, neither statement is true. There may be a minute disturbance in the equipment

Fig. 15
Good grouping patterns show progressively increasing grouping sizes as shooting distances increase.

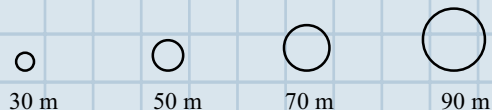

Fig. 16
Excessive Drag

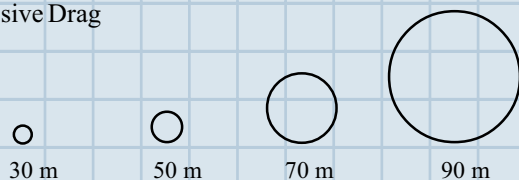

Fig. 17
Insufficient Clearance

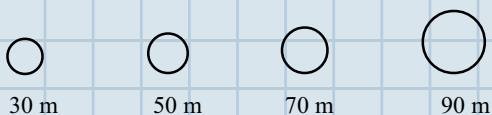

Fig. 18
Poor close range grouping
Acceptable long range grouping

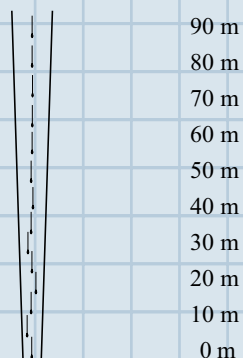
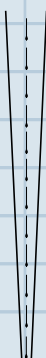

Fig. 19
Path without disturbance



that affects the equipment's potential for superior accuracy and causes poor arrow grouping. What follows here is information that will help you perform the fine tuning adjustments necessary to eliminate most or all of the minute tuning problems.

Many archers have experienced one or all of the following arrow grouping/arrow flight combinations:

Poor arrow flight and good grouping - This is commonly the result of a stiff arrow. The arrow yaws slightly as it leaves the bow, but usually recovers quickly and often produces very acceptable grouping.

Good arrow flight and poor grouping - Although this seems contradictory, the phenomenon is somewhat common and relates to the tuning method you use. Having a perfect bullet hole through paper using the Paper Tuning Arrow Test, or having the bare shafts impact exactly with the fletched shafts using the Bare Shaft Planing Test, does not always mean your arrows will group well; it only indicates you have good arrow flight. For this reason, Easton has developed the Fine Tuning and Micro Tuning methods, to assist you in obtaining optimal grouping from your equipment.

Poor arrow flight and poor grouping - This is most often a problem of mismatched arrow spine or untuned equipment. The information and tuning procedures in this bulletin should help you correct this problem.

Good arrow flight and good grouping - This should be the end result of your efforts!

Arrow grouping patterns often reveal probable arrow flight problems. Two of the most common grouping indicators for determining arrow flight problems are described below. The examples provided are shown in FITA distances, although they easily correlate to any long- and short-distance shooting. Fig. 15 illustrates good grouping patterns at the distances indicated.

Excessive Drag

The grouping examples in Fig. 16 show a large pattern at long distances (90 m) but the grouping is within acceptable limits at closer distances. This pattern implies the arrow has too much drag. Excessive drag will cause the arrow to become unstable due to the rapid decay of its forward velocity. When forward velocity drops too quickly, instability occurs. This unstable flight causes poor grouping at long distances and extreme vulnerability to wind drift. On light weight arrows, it is very important to reduce drag to a minimum to maintain maximum downrange velocity. This can be done by reducing the size (height and/or length) of the fletching or by reducing the angle of the fletching, or both.

Insufficient Clearance

The grouping patterns in Fig. 17 show acceptable grouping at the two long distances. However, the shorter distance groups are not reduced in size proportionately to the longer distance groups. (Compare to Fig. 15). This usually indicates a clearance problem or micro distur-

bance within the bow and arrow system. To correct, see the section on Clearance on page 5 or the Fine Tuning and Micro Tuning sections on pages 12-14.

Fig. 18 illustrates why you may have problems with close distance grouping while long-distance groups are good. When an arrow is shot, it is at its maximum bending as it leaves the bow. As the arrow travels further, the amount of flexing reduces (dampens). If the flexing reduces, then so does the magnitude of any original disturbance. The example shows that the arrow has some disturbance and close range grouping is poor, although the arrow stabilizes at longer range and provides acceptable groups. Micro disturbances and clearance problems usually cause these disturbances.

Fig. 19 shows the path of the arrow when it leaves the bow without any disturbance. This is the path you are trying to achieve in the Fine Tuning and Micro Tuning processes.

ADJUSTMENTS WITHIN THE BOW AND ARROW SYSTEM

If you are having problems tuning your bow, you will need to make some modifications to your equipment to achieve a better tune. Here are some suggestions:

Bow Weight Adjustment

Virtually all compound bows, as well as some recurve bows, have an adjustable draw weight. If your arrow reaction is too stiff, increase the draw weight. If your arrow reaction is too weak, decrease the draw weight.

Bowstring

Bowstring "weight" can have a significant effect on arrow spine. Increasing or decreasing the number of strands in the bowstring can influence the arrow's dynamic spine enough to require a shaft size change of one full size weaker or stiffer. If your arrow reaction is too stiff, decrease the number of strands in your bowstring. If your arrow reaction is too weak, increase the number of strands. Serving weight (center serving) can also produce the same effect. For example, monofilament center serving will cause the arrow to react stiffer than lighter weight nylon center serving. Simply changing from a metal nocking point to a "tie-on" nocking point can have a noticeable effect on arrow spine, due to the weight difference between the two styles of nocking points.

The bowstring is a critical part of your technical equipment. If you have a very difficult time tuning your bow, the problem could be the bowstring. An incorrectly made bowstring can produce a tension imbalance in the strands of the string causing some strands to be looser than others. This imbalance forces the string to load and stretch at different rates, creating an inconsistent arrow launch which greatly decreases accuracy. If a problem exists, and tuning procedures don't seem to be working, try changing the string and retuning.

Point and Insert Weight

X10, A/C/E and A/C/C, & Beman ICS arrows can be tuned by using various point and/or insert weight combinations. External component systems use weight combinations of point plus outsert. Aluminum arrows can be point-weight-tuned by using 7%, 8% or 9% F.O.C. NIBB points. If your arrow is too weak, go to a lighter insert/point. If your arrow is too stiff, try a heavier insert/point. Continue to change insert and/or point weight within the acceptable balance point range (7-16% F.O.C.).

Brace Height

For recurve bows, another way of altering arrow spine is with the brace height. By increasing or decreasing the distance from the bowstring to the pivot point of the grip, the dynamic spine of the arrow can be made slightly weaker or stiffer. Increasing brace height will make the arrow shoot weaker, and decreasing brace height will make the arrow shoot stiffer.

Brace height affects arrow spine by increasing or decreasing the amount of energy delivered to the arrow at the moment of release. Raising the brace height (shortening the bowstring) compresses the limbs, increasing stress (prestress or preload) in the limb material. The more preloading of the limbs, the greater the actual bow poundage at full draw. The reverse is true when lowering brace height. A lower brace height (lengthening the bowstring) reduces the prestress in the limbs and reduces bow weight at full draw.

RECURVE BOW LENGTH	MAXIMUM BRACE HEIGHT RANGE
64"	7 ³ / ₄ " - 9" (19.7 cm to 22.9 cm)
66"	8" - 9 ¹ / ₄ " (20.3 cm to 23.5 cm)
68"	8 ¹ / ₄ " - 9 ¹ / ₂ " (21.0 cm to 24.1 cm)
70"	8 ¹ / ₂ " - 9 ³ / ₄ " (21.6 cm to 24.8 cm)

However, raising brace height produces some small loss in arrow velocity as the slight increase in draw weight does not equally compensate for the reduction in the bow's "power stroke." When the power stroke is reduced, the amount of time the arrow stays on the bowstring is also reduced, in turn, decreasing the length of time the arrow has to absorb the bow's energy.

Although you may note a small loss in velocity when increasing brace height, do not let speed be the deciding factor when selecting the best brace height for your bow. As is often said, "Better to have a slow bull's eye than a fast miss."

Adjusting the brace height on a compound bow is often overlooked as a tuning adjustment. This is because the changes in brace height will change the draw length and draw weight possibly requiring additional adjustments. Nevertheless, finding the correct brace height for your compound (usually higher than the manufacturer's setting)

can, in many cases, greatly improve consistency and grouping and should be considered as a fine tuning adjustment.

The chart on the previous page shows the full range of brace height adjustments for most modern recurve bows. Changes within the brace height ranges shown can affect arrow spine as much as changing the arrow point and/or insert weight approximately 20 grains (1.3 grams). Remember, it is best to shoot your bow at its smoothest and quietest setting, (although most recurve bows perform well at two brace height settings). Easton does not suggest an extreme range of brace height. The chart offers a range wide enough to create a “between” size arrow spine.

If, after trying all of the tuning procedures listed, you find your arrows are still too weak or too stiff to fly properly, choose a different arrow size and retune.

BROADHEAD TUNING

In general terms, broadhead tuning is done by first shooting a group of arrows with field points into the target, and then by shooting a group of arrows with broadheads. The two groups are compared and the appropriate adjustments are made.

CAUTION: Never shoot unfletched shafts with broadheads—flight is extremely erratic and dangerous!

The field points should be as close in weight as possible to the weight of the broadheads. Because it is necessary to first establish a good group with field points, broadhead tuning can be done only after acceptable tuning has been established with field points.

Shoot a Group with Field Points

Set up a suitable broadhead target at a distance of 20 to 30 yards. Using a set of field-tipped arrows that have been tuned with your bow, shoot a group of 3 or 4 arrows into the target. Take care to shoot as good a group as you are capable.

Shoot a group with Broadheads

Using identical arrows tipped with broadheads, shoot a group of 3 or 4 arrows into the target. Use the same aiming spot that was used for the field points.

The shot group is the key. If you are content you have shot a respectable group based on your ability, then compare the position of the two groups. Make the adjustments listed below to your setup and shoot both groups again. Keep adjusting and shooting until both groups (field points and broadheads) group in the same area.

Make Adjustments

See Fig. 20 below and adjustments on next page.

Fig. 20
Broadhead Tuning

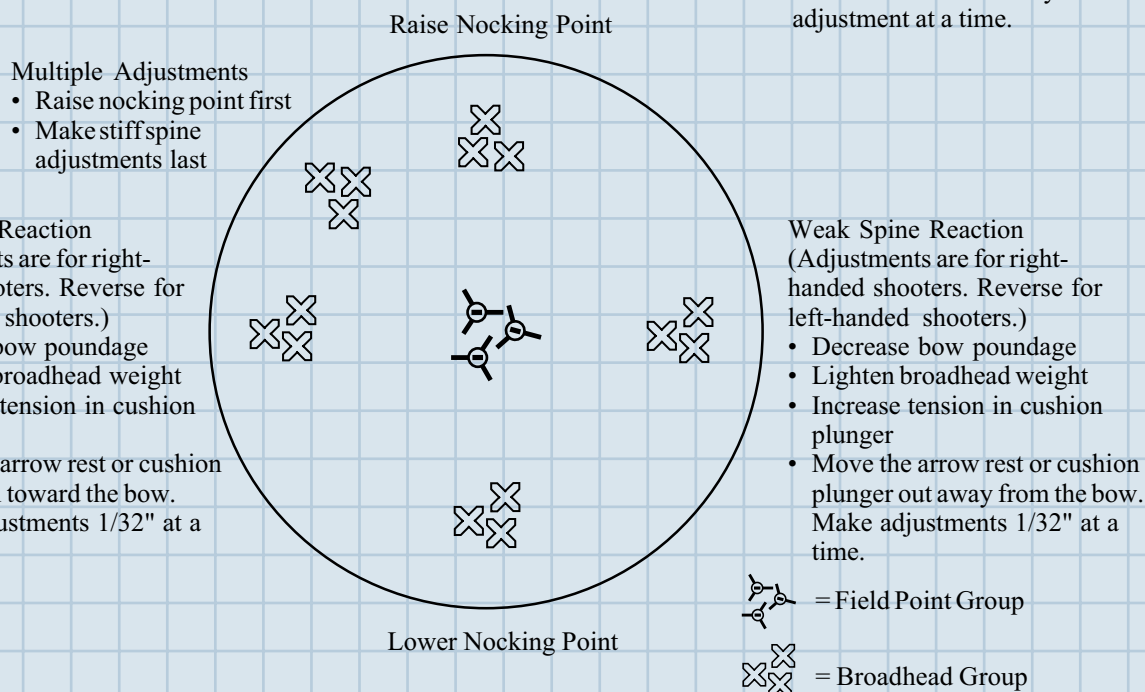

Adjustments

Adjustments sometimes effect more than is expected. It is best to always make the up/down adjustments first. Once the two groups are on the same horizontal plane, then make the left/right adjustments.

1. If the broadheads group above the field points, move the nocking point up.
2. If the broadheads group below the field points, move the nocking point down.
3. If the broadheads group to the left, they are behaving as if the shaft is too stiff (for a right handed archer). Any, or several, of the following can be done to correct the point of impact.
 - Increase the poundage on the bow.
 - Change to heavier broadheads.
 - If you are using a cushion plunger, decrease the spring tension.
 - Move the arrow rest or cushion plunger in toward the bow. Make adjustments $\frac{1}{32}$ " at a time
4. If the broadheads group to the right, they are behaving as if the shaft is too weak. Any or several of the following can be done to correct the point of impact.
 - Decrease the poundage on the bow.
 - Change to lighter broadheads.
 - If you are using a cushion plunger, increase the spring tension.
 - Move the arrow rest or cushion plunger out away from the bow. Make adjustments $\frac{1}{32}$ " at a time.

Remember, broadhead tuning can only be accomplished after the bow has been properly setup and tuned with field or target points.

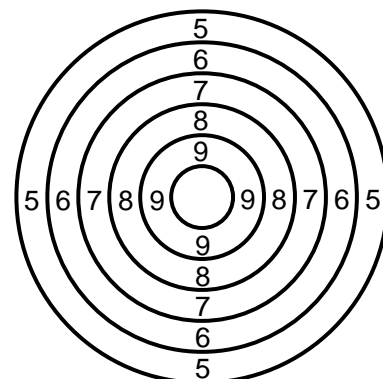
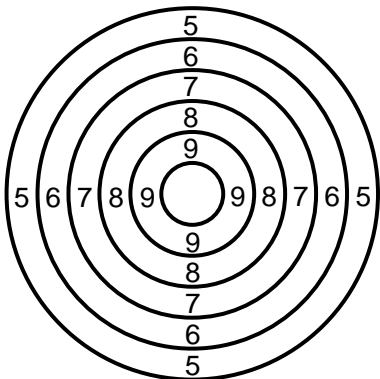
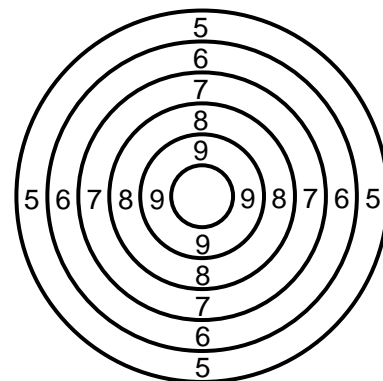
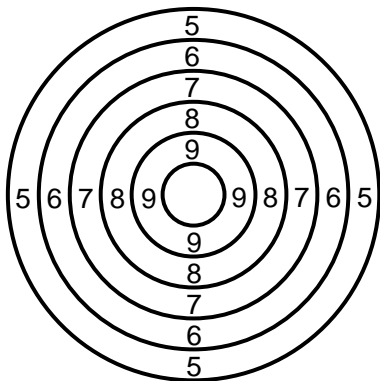

FINE TUNING

The Fine Tuning process is similar to Micro Tuning but slightly less refined. You will need a pencil and paper and several copies of the sample targets provided below.

1. Write down the exact measurements of your bow. For example:
 - a. Nocking point height
 - b. Brace height
 - c. Tiller
 - d. Number of strands in the bowstring
 - e. Bow draw weight
 - f. Type of stabilizers used, etc.
 In other words, everything you can think of to document your equipment.
2. Number your arrows. This enables you to plot groups and to plot each individual arrow impact.
3. Prepare to shoot from a comfortable distance, somewhere between 40 to 60 yards (meters).
4. Shoot an end or two to warm up before starting.
5. After warming-up, shoot a group of 6 to 10 fletched arrows.
6. Write down the number of each arrow and the impact point on the sample target.
7. Repeat steps 5 and 6 and compare. You want to achieve similar results initially.
8. Make adjustments as described on the following page.

Up-Down Impact

Adjust the nocking point $\frac{1}{32}$ " (.8 mm) either up or down. Shoot another two groups and plot the arrows in the same manner as described on page 12. For future reference, be sure to write down your bow adjustment on each arrow group you plot. Compare the groups to determine if the high and low arrow impact has improved or is worse. If it has improved, make another adjustment of $\frac{1}{32}$ " (.8 mm) in the same direction and shoot another two ends. If the high and low arrow impact is worse, go back to the original setting and make the same adjustment in the opposite direction. Continue this process until you achieve the most consistent group elevation.

Left-Right Impact

CF and CR shooters can adjust the left/right position of your arrow rest approximately $\frac{1}{32}$ " (.8 mm) either in or out. Shoot two groups and plot the arrows. Be sure to indicate your bow adjustment on each plotted arrow group. Compare the groups you just shot and determine if they are getting better or worse. If the groups improved, make another adjustment of $\frac{1}{32}$ " (.8 mm) in the same direction and shoot another two ends. If the groups are worse, go back to the original setting and make the same adjustment in the opposite direction. Continue this process until the best possible groups have been achieved with this single adjustment.

After left/right adjustment of the arrow rest or cushion plunger, CF shooters can adjust the spring tension of the cushion plunger $\frac{1}{8}$ - to $\frac{1}{4}$ -turn weaker or stiffer and continue the procedure, making $\frac{1}{8}$ -turn adjustments at a time to achieve a finer tune.

Remember, RF archers should adjust the cushion plunger pressure only, increasing or decreasing the spring tension $\frac{1}{8}$ -turn at a time. Do not move the in/out position of your arrow!

Reading the Plotted Arrow Groups

Carefully examine the arrow grouping patterns you plotted. Note the different shapes of the groups and how the adjustments altered the arrow impact and size of the groups. Examine each arrow by its number. Take careful note of any arrows that did not group consistently with the other shafts. You will probably want to mark these shafts so you will know not to use them in competition.

Identifying Arrow Problems

You may find an arrow that does not group well with the other arrows in the set. Examine it before you discard that arrow or retire it from competition. Sometimes a problem is easily identified. If a shaft is cracked or dented it should be discarded.

Some arrows may seem fine, but they may have problems which are not obvious and can cause the arrows not to group well. The following list includes the common arrow problems, many of which can cause tremendous impact variations.

Arrow Straightness

Arrows must be straight for tight grouping. Easton recommends straightness within 0.004" for best grouping.

Crooked Nocks

There are several ways to check nock straightness, including commercially available nock gauges and broad-head spinning wheels.

Nock Indexing

It is possible that one nock in the set may be turned more than the others. A clearance problem results if the nock is rotated too far, forcing the fletching into the arrow rest when shot.

Loose or Damaged Fletching

If the fletching becomes even slightly detached from the shaft, the arrow will not group with the others. In fact, the arrow may not even hit the target past 30 yards (meters) if the back of any fletch is slightly loose! Fletching that is slightly damaged will not usually affect arrow grouping unless you shoot a hard or rigid vane. Care should be taken to examine hard vanes each time you shoot to ensure that no vanes are damaged. If the rear of any hard vane is bent, it will produce a rudder effect, causing large deviation in impact.

Loose Points/Inserts

Many archers are not aware of this potential problem. Points must be properly installed with Easton's hot melt adhesive fully coating the entire length of the shank of the point or insert. Carefully follow the instructions on point/insert installation which follow later in this Guide. Easton recommends only Easton's hot melt adhesive. If you are using another hot melt ferrule cement, it may be too brittle and may fracture when the arrow impacts hard target butt materials. If the cement fractures or is improperly applied, it can result in a separation between the point/insert and the shaft. When the arrow is shot, the separation of the bond between the shaft and point can produce a secondary vibration which in turn affects the arrow's natural vibration and accuracy. To test for point vibration, simply hold the arrow near the fletching and lightly tap the point on a table, or drop the arrow on a hard floor from a height of one foot. If you hear a buzzing sound, the point/insert is probably loose. Heat and pull out the point/insert and properly reinstall per Easton's instructions on page 19.

Arrow Weight

Arrow weight is an important consideration for the serious tournament archer and should be checked if you have arrows which consistently impact a little high or low of your group.

A matched set of arrows should have no more than a three grain spread between the heaviest and lightest arrows in the set. Top tournament archers frequently match their arrows to one grain or less.

MICROTUNING

Micro Tuning adjustments are similar to Fine Tuning and are designed to produce optimum grouping at all distances.

1. Prepare to shoot from the longest distance you would normally shoot in competition.
2. Shoot at least 8 to 10 arrows.
3. Measure and record the distance between your highest and lowest arrow.
4. Shoot a second group of arrows before making any adjustments.
5. Again, measure and record the distance between your highest and lowest arrow.
6. Repeat steps 2-5 with each of the following adjustments:

Up-Down Impact

Make no more than a $\frac{1}{32}$ " (.8 mm) change in nocking point height either up or down. Shoot two more ends and record the distance between the highest and lowest arrow. If the combined distance between the last two groups is less than the combined total of the first two groups, you are making the correct adjustment. Continue to make $\frac{1}{32}$ " (.8 mm) nocking point adjustments until you achieve the shortest possible distance between your high and low arrows.

If after several nocking point adjustments, you notice the group height starting to open back up, you have probably gone too far in the adjustment and need to go back to where you had the best setting.

Left-Right Impact

Once you are satisfied with the impact height of your arrows, you will need to correct the left/right impact. Continue shooting groups of 8 to 10 arrows. Shoot two ends and measure the distance between the furthest left and furthest right arrows for both ends.

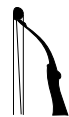

For compound archers (CF and CR), move the in/out position of your arrow rest $\frac{1}{32}$ " (.8 mm) in either direction. Shoot two more groups and again measure the distance between the furthest left and right arrows. Compare these two ends against the previous two ends. If the total width of the grouping pattern has reduced, you are making the correct adjustment. If the group becomes wider, go back to your original setting and move the rest $\frac{1}{32}$ " (.8 mm) in the opposite direction and resume the test. Continue these adjustments until you have achieved the tightest possible grouping at that distance.

CF archers using cushion plungers should make the in/out adjustments first until you have achieved the tightest left/right impact possible. Then, you can use the cushion plunger spring tension the same as described for recurves to fine tune your arrow impact.



Recurve archers (RF) should adjust only the cushion plunger spring tension, not the in/out adjustment. Make adjustments to the cushion plunger spring tension in $\frac{1}{8}$ turn increments only. Follow the same instructions as for compound bows by first shooting two groups and measuring the furthest left and right arrows. Make the first spring tension adjustment either stiffer or weaker and shoot two more ends. Again, if the group becomes wider, go back to the original setting and make an adjustment $\frac{1}{8}$ of a turn in the opposite direction.

Once you have completed the long distance tuning, move up 20 yards (18 m) and work on the left/right impact again, making the same adjustments as at the previous distance. It should not be necessary to adjust the nocking point, only the adjustments for left/right grouping. After you have completed this distance, move 20 yards (18 m) closer and repeat this test again for left/right impact only.

Continue this process until your last distance is approximately 20 yards (18 m) from the target. You may find that as little as $\frac{1}{8}$ of a turn on the cushion plunger or a $\frac{1}{32}$ " (.8 mm) in/out adjustment (for compound bows) can have a noticeable effect on short distance grouping. It is essential to continue testing and tuning in 20 yard (18 m) increments. This way, you will know that your equipment can perform well at any distance when shooting competition.

This same fine tuning procedure can be done with brace height for both compound bows and recurves. Make brace height adjustments in approximately $\frac{1}{32}$ " (.8 mm) increments and plot the arrow groups. After completing this procedure, you should find a combination of adjustments that will either slightly or significantly improve arrow grouping.

Points to Remember:

Install all accessories on your bow before you start any bow tuning procedures.

An essential part of your equipment is a good quality set of arrows.

Adjustments made to the bow, changes in bow components, or alterations in shooting form can affect the tune or your equipment. Remember, you and your equipment share a unique relationship and are totally integrated. Any change to either will produce varying effects.

Change only one variable at a time when tuning.

If, after trying all of the tuning adjustments outlined in this Tuning Guide, your arrows still do not fly true, it may be necessary to change your arrow size to a stiffer or weaker shaft and retune.

**The tuning methods were compiled and edited by Don Rabska with contributions from Terry Ragsdale, Fred Troncoso, and others.

ARROW ASSEMBLY

Cutting Shafts, Installing Components, and Arrow Maintenance

Contents

This section of the *Arrow Tuning and Maintenance Guide* contains instructions for the assembly of shafts and components. It starts with functions that apply to all types of shafts (with noted exceptions)—determining correct length, measuring shafts, and cutting shafts.

Methods for installing points and fletching vary based on the type of shaft being used, so these instructions are grouped based on their generic shaft type—Aluminum, Aluminum/Carbon, Carbon with internal components (ICS), and Carbon with external components.

Most shafts can be used with at least two types of nock systems, so the nock systems are all grouped together in one section following the point and fletching sections for the various shafts.

The last part of the Guide contains additional information of a more general nature, including F.O.C. calculations, AMO’s minimum recommended arrow weights, and safety tips.

MEASURING AND CUTTING SHAFTS

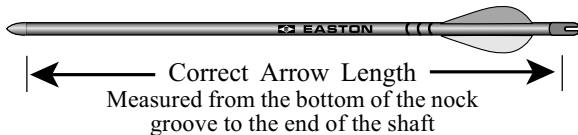

Correct Arrow Length

Correct Arrow Length is measured from the bottom of the nock groove to the end of the shaft (see diagram). This distance includes a portion of the nock, the nock insert or outsert if any, and the shaft length. The point is not included. This is the length used for shaft selection.

The optimum length of a finished arrow for a specific archer is determined by several factors including the draw length of the archer, the style of point, the configuration of the bow, and the archer’s shooting style. To determine your correct arrow length, use the procedures that follow.

Measuring Correct Arrow Length

Your Recommended Correct Arrow Length can be determined by drawing back an extra-long arrow and having someone mark the arrow. This distance is measured from the front of the bow or from the front of the place where the arrow contacts the most forward position of the arrow rest. Which method to use depends on the type of bow and arrow being set up.

To determine the proper distance for a specific setup, find the appropriate illustration (Figures 21-26). From this you can measure your arrow length and know where the shaft should be cut.



Recommended Correct Arrow Length

X10, A/C/E, A/C/C, HyperSpeed, Aluminum, and Carbon Shafts with Internal Components

For hunting arrows shot from bows with cutout sight windows (including overdraw bows) and for target/field/3-D arrows shot from all types of bows, it is recommended that the Correct Arrow Length be determined by drawing back an extra-long arrow and having someone mark the arrow about 1" in front of the place where the arrow contacts the most forward position of the arrow rest. This extra 1" provides a measure of safety by allowing small variances in draw length to occur without resulting in a target arrow falling behind the arrow rest or an arrow with a broadhead falling off from contacting the arrow rest. This measurement is your Correct Arrow Length and is where your shaft should be cut (see figure 21).

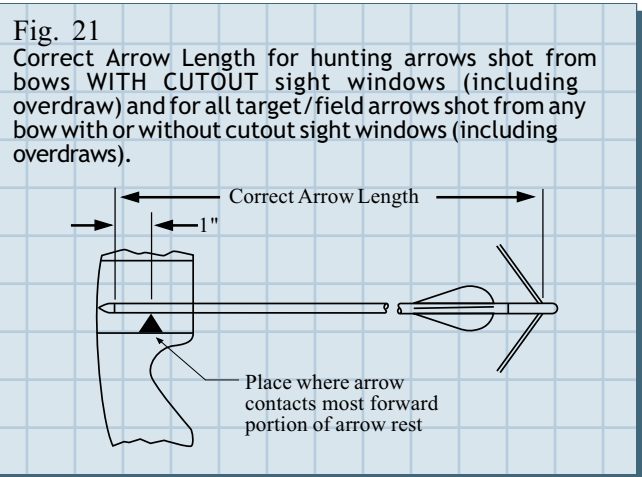
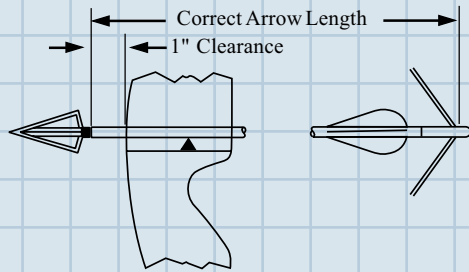

Fig. 21
Correct Arrow Length for hunting arrows shot from bows WITH CUTOUT sight windows (including overdraw) and for all target/field arrows shot from any bow with or without cutout sight windows (including overdraws).

For hunting arrows on bows without cutout sight windows your broadhead should have at least 1" bow clearance past the far side of the bow. Have someone mark an extra long arrow while you're at full draw about 1" beyond the back (far side) of the bow (see figure 22).

Fig. 22
Correct Arrow Length for hunting arrows with broadheads shot from bows WITHOUT CUTOUT sight windows (or not cutout enough for broadhead clearance).



Recommended Correct Arrow Length (Carbon Shafts with External Components)

Some shafts are fitted with components that fit over the outside of the shaft. To accommodate this, the outserts and one-piece points must be larger in diameter than the shaft. Therefore, all Correct Arrow Length calculations allow for at least 1/2" clearance from the back of the One-Piece Point or Standard Adapter to the most forward part of the arrow rest (as indicated by the diagrams). This prevents any disturbance to the arrow caused by the outsert as the arrow is drawn or released.

Fig. 23
Correct Arrow Length for target arrows with One-Piece Points shot from ALL TYPES of bows (with or without cutout sight windows and with or without overdraw).

For target points Correct Arrow Length is measured from 3/4" in front of the most forward part of the arrow rest.

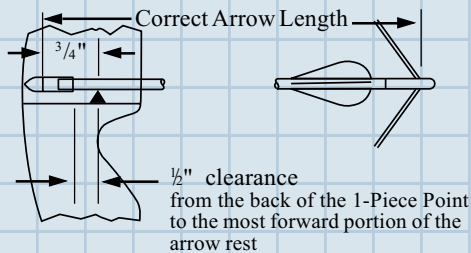

NOTE: Beginners with recurve bows may want to add an extra 1/2"-1" to their arrow length so that, as they become stronger and their shooting technique improves, the arrow will not be too short.

Fig. 24
Correct Arrow Length for hunting arrows shot from bows WITHOUT CUTOUT sight windows (or not cutout enough for broadhead clearance).

NOTE: On bows without cutout sight windows the broadhead cannot be pulled "into the bow." It is necessary, then, to provide enough broadhead clearance in front of the bow when the arrow is pulled to full draw to prevent the broadhead from bumping against the bow.

Correct Arrow Length is measured from 1/4" beyond the far side of the bow.

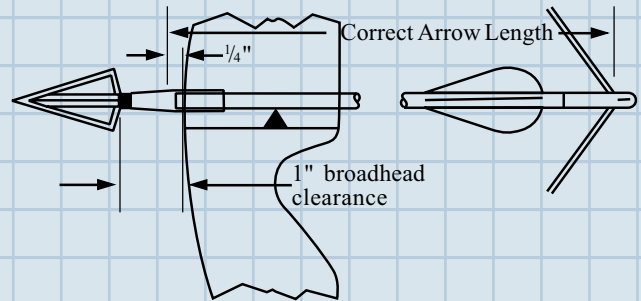

Fig. 25
Correct Arrow Length for hunting/field arrows equipped with Point Outserts and broadheads or screw-in points shot from bows WITH OVERDRAWS AND CUTOUT sight windows.

Correct Arrow Length is measured from 1 1/8" in front of the most forward part of the arrow rest.

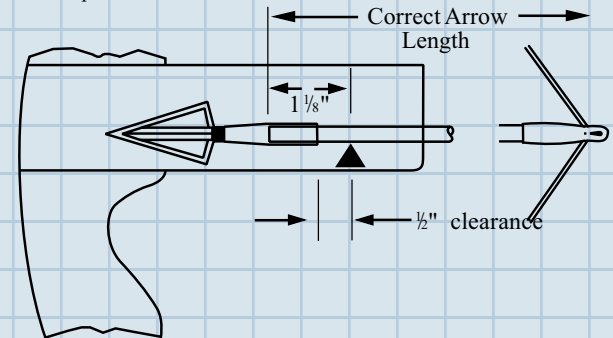
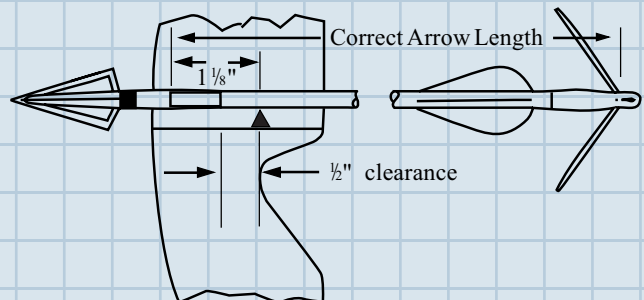

Fig. 26
Correct Arrow Length for all arrows shot from bows WITH CUTOUT sight windows (no overdraws).

Correct Arrow Length is measured from 1 1/8" in front of the most forward part of the arrow rest.



Determining Shaft Cut length

Remember that your Correct Arrow Length is measured to the bottom of the nock groove and includes the small distance that the nock base extends beyond the nock taper. Therefore, your shaft cut length is slightly shorter than your Correct Arrow Length.

Cutting Shafts to Length

After determining Correct Arrow Length follow the steps below.

Note: Carbon shafts of all types must be cut carefully to prevent splintering of the carbon (graphite) fibers.

Never use rotary tube cutters, hack saws or other methods that can damage the shaft or leave a rough cut. Always wear a NIOSH approved dust mask and safety glasses when cutting arrow shafts !

1. Set up the Easton Pro Shop Cut-Off Tool to cut the shaft so that after the nock system is installed, the total length of the shaft plus nock system will equal your desired Correct Arrow Length. To do this you will have to temporarily install the nock system on one full length shaft and then use that shaft to measure and set up the proper cutoff length.
2. Set the shaft support on the Cut-Off Tool so the abrasive wheel only cuts about $\frac{1}{3}$ through the diameter of the shaft as shown in Fig. 28 (above right).
3. While slowly rotating the shaft in the same direction as the cutoff wheel, gently push the shaft into the wheel and rotate the shaft until it is completely cut. Continue to slowly rotate the shaft two more revolutions to ensure a square cut.
4. Deburring and chamfering is the final step. What needs to be done varies with the type of shaft (see diagrams to the right).

ALUMINUM—Deburr only the inside of the wall just enough to eliminate the sharp edge of the tube.

A/C/E, A/C/C and HyperSpeed—Deburr the inner aluminum core tube very lightly using the more pointed deburring head on Easton's Cut-Off Tool. Be careful not to remove too much aluminum.

Beman ICS (Internal Component System)—Do not chamfer the inside of the tube.

ICS Hunter (Internal Component System)—Deburr the inside of the tube just enough to remove the burr.

All Carbon with External Components—These components fit over the outside of the shaft, so chamfering must be done on the outside edges of the shaft (see illustration on right). Use the recessed grinding stone on the Cut-Off Tool or lightly chamfer the end of the shaft with 180- or 240-grit sandpaper. Rotate the shaft as you lightly drag the edge of the shaft along the sandpaper. Three complete revolutions will produce a sufficient chamfer.

5. Easton recommends that you test-draw one arrow with all components installed (without adhesive) before cutting and finishing a complete set of arrows.

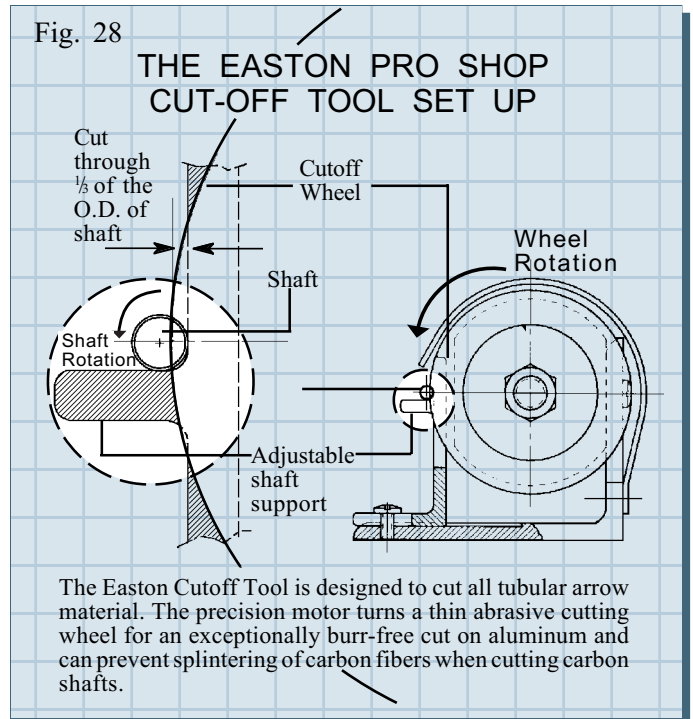

Easton Aluminum

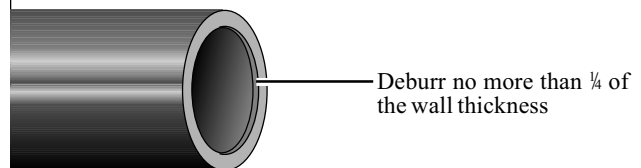

Easton X10, A/C/E, A/C/C, HyperSpeed

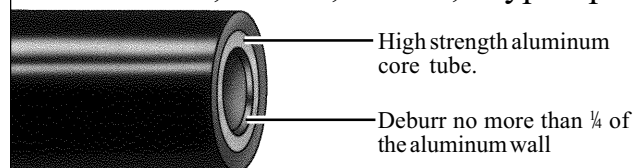

Beman ICS and ICS Hunter

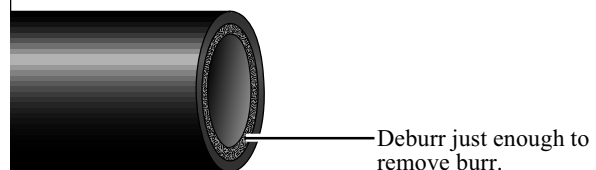

Beman External Component Shafts

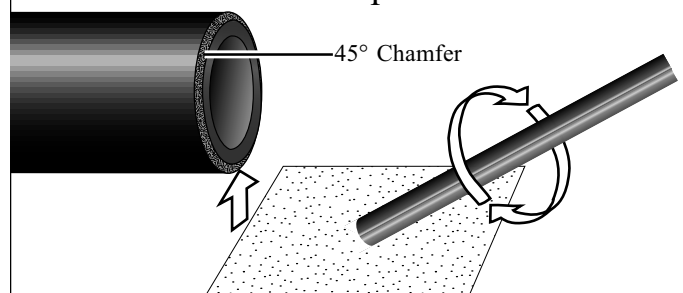

ALUMINUM SHAFT COMPONENT INSTALLATION

Shaft Construction

Easton shafts, depending on the model line, are produced from super high-strength 7178 or 7075 aluminum alloys. Both alloys are processed to their highest possible strength using Easton's proprietary manufacturing steps. This insures that Easton shafts will stay straight even through severe shooting conditions.

Easton shafts are cold drawn many times from an aluminum tube that has been fusion bonded from precision coil stock. This tube has a precisely uniform spine because it is made from uniform thickness coil stock, drawn many times, and thermally treated until the fusion line is totally absorbed into the adjacent metal. To further ensure integrity of every shaft, each Easton aluminum shaft goes through an eddy current tester that "looks" through the wall thickness and rejects any shafts with flaws or imperfections in the material.

Each Easton aluminum shaft of a given size and model is guaranteed to have the same inside diameter to a tolerance of ± 0.0004 ". This close tolerance ensures a consistent point or insert fit. The outside diameter is made to ± 0.0003 " tolerance to ensure a uniform spine from shaft to shaft. In addition, the wall thickness is uniform to give consistent spine 360° around each shaft.

Shaft Size Identification

Easton uses various arrow shaft outside diameters and wall thicknesses to obtain the necessary number of shaft spines needed to shoot well from nearly all bow weight and arrow length combinations.

The Outside Diameter is the main factor in determining shaft stiffness. This diameter is coded in the first two digits of the shaft size number—for example, in 2312, the 23 = 23/64". This is the shaft diameter rounded to the nearest sixty-fourth of an inch. The Wall Thickness code is the second two digits of the shaft size number. These digits indicate the shaft wall thickness to the closest one thousandth of an inch—for example, in 2312, the 12 = 0.012". The wall thickness is the main factor in determining the shaft weight. For two shafts of the same stiffness, a larger diameter, thin-walled shaft will be much lighter than a smaller diameter, thicker walled shaft.

Easton Aluminum Shaft Weight Groups

Easton aluminum shafts are classified by weight groups, each with its own performance characteristics. There are shaft sizes in each weight group to match nearly every bow weight/arrow length combination.

- *UltraLite* aluminum – .012" wall thickness
- *SuperLite* aluminum – .013" - .014" wall thickness
- *Lite* aluminum – .015" - .016" wall thickness
- *Standard* aluminum – .017" - .020" wall thickness

INSTALLING POINTS AND ALUMINUM INSERTS

MATERIALS NEEDED FOR INSTALLATION OF POINTS AND ALUMINUM INSERTS

- 91% isopropyl alcohol
- paper towels
- cotton swabs
- Easton hot-melt
- torch or burner

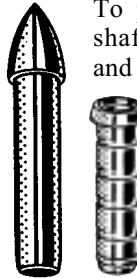

To produce the most bend-resistant aluminum shaft possible, extremely high-yield strength and internal stresses are built into each Easton shaft. Therefore, care must be taken when installing a point or insert to prevent splitting the end of the shaft due to over stressing. Easton two-piece points and RPS aluminum inserts for aluminum shafts have an exclusive press-fit feature on the last $\frac{1}{8}$ " (3 mm) of the insert. This feature accurately aligns the component in the shaft and holds it in place while the adhesive hardens.

Follow the shaft cutting instructions carefully, then follow the steps below for point and aluminum insert installation.

NOTE: To facilitate handling, Easton recommends that a field point be screwed into the insert before heating and inserting.

CAUTION: Do not overheat aluminum shafts or points! This is especially true with thin wall *UltraLite* shafts which heat up more quickly than other aluminum shafts. Excessive heat (over 400°F [200°C]) will cause recrystallization and could permanently soften or damage any size aluminum shaft.

1. Clean the inside of the shaft with a cotton swab dipped in 91% isopropyl alcohol to remove the fine cutting dust. Let the shaft dry thoroughly before bonding.
2. With a small gas flame, apply enough heat to the end of the shaft to readily melt a ring of Easton's hot melt adhesive on the inside of the shaft. **NOTE:** Use Easton's Hot Melt Adhesive only. Arrow points can come out in the target mat if adhesives with lower melting temperatures are used.

CAUTION: Do not overheat!

3. Grip the point or insert with pliers and heat the shank end just enough so that when it is pushed partly into the shaft, the ring of adhesive is melted. Push the point or insert about $\frac{1}{4}$ " (6 mm) into the shaft.

CAUTION: Do not overheat points!

4. Heat the exposed portion of the point or insert shank just enough so a thin layer of hot melt adhesive can be applied to the exposed shank of the point or insert.
5. After applying the adhesive, heat and remelt the adhesive on the shank of the point or insert.
6. Without delay, while the adhesive is still fluid, slowly push the point or insert into the shaft until it seats against the end of the shaft. Wipe off excess adhesive on a paper towel before hot melt hardens.

REMOVING POINTS AND ALUMINUM INSERTS

When removing an aluminum insert, first thread an RPS Field or Target Point into the insert.

1. Lightly heat the exposed end of the point for 3-5 seconds over a small gas flame.

CAUTION: Do not overheat the component or the shaft.

2. Immediately grip the point with a pair of pliers.
3. Twist and pull out the point (and insert if any).
4. If the point or insert cannot be removed, reheat for 3-5 seconds and try to remove again.
5. Repeat procedure #4 until adhesive softens just enough to remove the component.

INSTALLING CARBON COMPOSITE INSERTS

MATERIALS NEEDED FOR INSTALLATION OF CARBON COMPOSITE INSERTS

- | | |
|---------------------------------------------------------------------------------------------------------------------------|----------------------------------------------------------------------------------------------------------------------------------------------------|
| <ul style="list-style-type: none"> • 91% isopropyl alcohol • paper towels • cotton swabs | <ul style="list-style-type: none"> • flexible, two-part, 24-hour epoxy (such as AAE epoxy) • wood toothpick or match stick |
|---------------------------------------------------------------------------------------------------------------------------|----------------------------------------------------------------------------------------------------------------------------------------------------|



For an accurate, high-strength installation, be sure the shaft ends are cut square. Follow the shaft cutting instructions carefully.

1. Clean the inside of the shaft with a cotton swab dipped in 91% isopropyl alcohol to remove the fine cutting dust. Let the shaft dry thoroughly before bonding.
2. Evenly spread a drop of epoxy around the inside of the first 1/4" of the shaft with a wood toothpick or match stick.

NOTE: A twenty-four hour flexible epoxy such as AAE® Epoxy is best. Fast-drying epoxies are often brittle.
3. Apply a small amount of adhesive to the entire surface of the insert.
4. Install the insert, rotating it as it is pushed slowly into place. Wipe off excess adhesive.
5. Stand the shaft on the nock end while drying to prevent epoxy from entering the threaded area of the insert.

REMOVING CARBON COMPOSITE INSERTS

Carbon Composite Inserts can be removed by *slowly* heating the shaft (aluminum shafts only) and breaking down the bonding adhesive with heat.

CAUTION: Do not overheat the shaft!

1. Put an RPS Field or Target Point into the insert.

2. Lightly heat the end of the aluminum shaft for 3-5 seconds over a small gas flame.
3. Grasp the point in the insert with pliers and try to pull the insert from the shaft.
4. Repeat steps 1 and 2 until the adhesive bond is destroyed by the heat and the insert pulls free. Remember, excess heat will destroy the shaft.
5. Immediately, while the shaft is still hot, clean the inside of the shaft by removing any adhesive residue with a bore cleaning brush or small blade.

PREPARING ALUMINUM SHAFTS FOR FLETCHING

Unless your fletching jig has an adjustable nock indexing feature, you may choose to fletch your arrows with the nocks temporarily installed. After fletching, properly index and bond the nocks so that your style of vanes clears your particular arrow rest.

NOTE: If the nocks are installed without adhesive the UNI and Super UNI Systems allow you to rotate the nock to obtain proper alignment at any time.

Cleaning with Non-chlorinated Ajax® & Water

1. Rub the shaft in the area to be fletched with wet Ajax on a wet paper towel.
- NOTE:** Do not use chlorinated cleansers.
2. Rinse the shaft and repeat cleaning until water no longer beads, but "sheets" on the shaft surface.

Cleaning with Solvents

1. Carefully wipe down just the area of the shaft to be fletched with MEK, lacquer thinner, or acetone until no residue shows on a clean white paper towel.
 2. For the best bond, follow with a wipe of 91% isopropyl alcohol using a clean white paper towel.
- CAUTION:** Do not use MEK, lacquer thinner, or acetone with the nock installed. Keep these solvents away from nocks, shaft identification marks, and UNI Bushings. Use protective gloves to keep solvents from penetrating the skin and use proper ventilation.
- NOTE:** Petroleum solvents can accumulate between the bushing and the shaft wall and weaken the adhesive bond. Also, the vapors from trapped solvents could cause the polycarbonate A/C/E or 3-D Super Nocks to fracture when shot. Be sure the shaft has dried thoroughly before installing nocks.

Cleaning with 91% Isopropyl Alcohol (Recommended for shafts with UNI or Super UNI Bushings already installed)

1. Use 91% alcohol as a primary cleaner on shafts with UNI or Super UNI Bushings installed. 91% alcohol will not affect the A/C/E or Super Nocks or the bushing adhesive.

FLETCHING ALUMINUM SHAFTS



1. Because of the preapplied activator on Easton Diamond Vanes, no cleaning is required if AAE Fastset™ adhesive is used. If another brand of adhesive is used, or for other brands of vanes, wipe the base of the vanes with MEK or lacquer thinner to remove any mold release chemical from the vanes.
2. When preparing for fletching, observe these precautions and instructions:
 - a. Do not touch cleaned areas of the shaft or vanes with your hands or other objects.
 - b. Fletch as soon as possible after the shaft has dried. If shafts stand unfletched for over 8 hours, repeat the cleaning process.
 - c. Do not attempt to fletch on very humid days.
3. Shafts cleaned as described above can be fletched directly using Saunders® NPV, Fletch-Tite®, AAE Fastset®, or similar fletching cement. For added adhesion, a thin dip of lacquer or coating compatible with the cement can be used.

CAUTION: Do not dip shafts with UNI Bushings or Super UNI Bushings in lacquer or use petroleum solvents to clean the fletching surface.

Notes on Fletching Aluminum Shafts

1. Use Saunders® NPV, Fletch-Tite®, AAE Fastset® or similar fletching cement.
2. Set the rear of the vane 1-1¼" from the bottom of the nock groove.
3. Attach fletching at an offset to the centerline of the shaft. To assure proper clearance, take into account the type of arrow rest being used. Do not use an angle of offset so great that the farthest right or farthest left corner of the fletching loses contact with the shaft. There should be no open spaces between the shaft and the ends of the base of the vane.
4. Allow cement to fully harden before shooting. Follow manufacturer's instructions for full cure time.

REMOVING FLETCHING

1. Carefully scrape off the vanes and excess glue with a dull knife.
2. Wipe fletching area with MEK or lacquer thinner to remove vane and cement residue.

CAUTION: Keep solvents away from the nock and shaft identification markings.
3. For the best bond, follow with a wipe of 91% isopropyl alcohol using a clean paper towel.
4. Let dry and re-fletch.

ATTACHING NOCKS

See *Installing Nock Systems* later in this guide.

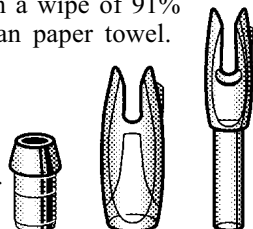

ALUMINUM/CARBON COMPONENT INSTALLATION

Installing One-piece Points and Aluminum Inserts

EQUIPMENT AND MATERIALS NEEDED FOR INSTALLATION OF POINTS AND ALUMINUM INSERTS

- 91% isopropyl alcohol
- paper towels
- cotton swabs
- Easton hot-melt
- torch or burner



The instructions that follow can be used for either One-piece Points or for aluminum inserts. For aluminum inserts, screw a point into the insert before you begin installation.

After cutting your A/C* Shaft to length as described, follow the point installation procedure carefully to prevent overheating the point. Overheated points can destroy the shaft's epoxy bond between the carbon and the aluminum tube. Use only Easton hot-melt adhesive.

1. Clean approximately two inches inside the point end of the shaft using a cotton swab dipped in 91% alcohol. Repeat the process until a fresh cotton swab is free of cutting dust residue. Let the shaft dry thoroughly before bonding.
 2. Carefully heat a stick of Easton's hot-melt adhesive over a small gas flame; then apply a ring of hot adhesive to the inside of the point end of the shaft.
- CAUTION:** Do not apply heat directly to A/C shafts.

Use Easton's hot-melt adhesive only. The melting point of Easton's hot-melt adhesive is low enough that the shaft will not be damaged during installation and high enough to keep the point securely bonded during the frictional heating caused when the arrow penetrates the target mat. Arrow points can come out in the target mat if lower melting temperature hot-melt adhesives are used.

3. Hold the end of the point with your fingers. (Do not hold with pliers because it is then possible to overheat the point.) Heat the exposed portion of the point or insert until you feel it getting warm. It should be just hot enough to melt the adhesive.
- CAUTION:** Do not overheat points. If the point becomes too hot to hold in your fingers, it is too hot to put in the shaft. Set the point on a noncombustible surface until cool.
4. Heat the hot-melt adhesive and apply a generous layer of adhesive to the shank of the point or insert.

* "A/C" Shaft refers to all models of aluminum/carbon shafts. Current models are X10, A/C/E, A/C/C, and HyperSpeed.

5. After applying the adhesive, quickly remelt the adhesive on the shank of the point or insert. Reheat it enough that when it is pushed into the shaft, the ring of adhesive in the shaft is melted.
6. Without delay, while the adhesive is still fluid, install the point or insert into the shaft with a clockwise twisting motion until it seats against the end of the shaft.

NOTE: Do not force a point or insert into an A/C shaft.

7. With a paper towel quickly wipe off excess adhesive while it is still hot.

CAUTION: Do not apply heat directly to A/C shafts or overheat points! Overheating points installed in A/C shafts can destroy the bond between the carbon and the aluminum tube. Applying heat directly to A/C shafts can destroy the carbon fiber/epoxy matrix.

Removing Points and Aluminum Inserts

1. Grasp the shaft about 1/2" back from the component. There should be 1/2" to 3/4" of shaft between your fingers and the component. (Screw a point into the aluminum insert before heating.)
2. Lightly heat only the exposed portion of the component in a small flame for 3-5 seconds.

CAUTION: Do not apply heat to A/C shafts directly.

3. When you feel the shaft just start to warm under your fingers, grip the component with a pair of pliers. Twist and pull on the component to determine if the adhesive has melted. (Or use a small wire hook to remove the UNI Bushing.)
4. If the component does not move, continue to heat in five second increments and twist the component after each heating period with pliers until it rotates and can be pulled free of the shaft.

Installing Carbon Composite Inserts

EQUIPMENT AND MATERIALS NEEDED FOR INSTALLATION OF CARBON COMPOSITE INSERTS

- | | |
|-------------------------|--------------------------------------------------------|
| • 91% isopropyl alcohol | • flexible two-part, 24-hour epoxy (such as AAE epoxy) |
| • paper towels | • wood toothpick or match stick |
| • cotton swabs | |



For an accurate, high-strength installation, be sure shaft ends are cut square. Follow shaft cutting instructions carefully.

1. Clean the inside of the shaft with a cotton swab dipped in 91% isopropyl alcohol to remove the fine cutting dust. Let the shaft dry thoroughly before bonding.
2. Evenly spread a drop of epoxy around the inside of the first 1/4" of the shaft with a wood toothpick or match stick.

NOTE: A twenty-four hour flexible epoxy such as AAE® Epoxy is best. Fast-drying epoxies are often brittle.

3. Apply a small amount of adhesive to the entire surface of the insert.
4. Install the insert, rotating it as it is pushed slowly into place. Wipe off excess adhesive.
5. Stand the shaft on the nock end while drying to prevent epoxy from entering the threaded area.

Removing Carbon Composite Inserts

Carbon Composite Inserts are permanently installed with epoxy and cannot be removed without risking damage to the shaft. Attempting to remove the inserts voids the shaft guarantee.

Preparing Shafts for Fletching

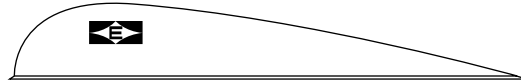

Unless your fletching jig has an adjustable nock indexing feature, you should fletch your arrows with the nocks temporarily installed without adhesive. After fletching, index the nocks properly so the fletching clears your arrow rest. If you wish, use one of the recommended adhesives to attach your nocks (See pages 26-29).

NOTE: If no adhesive is used the UNI System allows you to rotate the nock to obtain proper alignment at any time.

1. Carefully wipe down just the fletching area of the shaft with M.E.K. or lacquer thinner using a clean, white paper towel. If your nock is already permanently installed, use 91% isopropyl alcohol in place of all other solvents. Continue wiping the surface with solvent until no dirt or carbon residue shows on a clean portion of the paper towel. Remember to use protective gloves to keep solvents off the skin and use proper ventilation. Do not soak carbon or aluminum/carbon shafts in any solvents.

CAUTION: Do not use lacquer thinner, M.E.K., or acetone with the nock installed. Keep these solvents away from nocks and shaft identification markings. Petroleum solvents could accumulate between the bushing and shaft wall and weaken the adhesive bond. Also, the vapors from trapped solvents could cause the polycarbonate A/C/E Nocks to fracture.

2. For the best bond, follow with a wipe of 91% isopropyl alcohol using a clean paper towel.
3. Because of the preapplied activator on Easton Diamond Vanes, no cleaning is required if AAE Fastset™ adhesive is used. If another brand of adhesive is used, or for other brands of vanes, wipe the base of the vanes with MEK or lacquer thinner to remove any mold release chemical from the vanes.

When preparing for fletching, observe these precautions and instructions:

- a. Do not touch cleaned areas with hands or other objects.
- b. Fletch soon after cleaning. If shafts stand unfletched for over 8 hours, repeat the cleaning process.
- c. Do not attempt to fletch on very humid days.

Fletching A/C Shafts

EQUIPMENT AND MATERIALS NEEDED FOR FLETCHING

- | | |
|---------------------------------------------------------------------------------------------------|-------------------------------------------------------------------------------------------------|
| <ul style="list-style-type: none"> • 91% isopropyl alcohol • paper towels | <ul style="list-style-type: none"> • fletching jig • fletching adhesive |
|---------------------------------------------------------------------------------------------------|-------------------------------------------------------------------------------------------------|

Fletching for A/C target shafts should be as small as necessary to get good flight and grouping. Fletching for A/C hunting shafts should be large enough to stabilize the size and weight of the broadhead you use. Remember to always clean the shaft before attaching any style of fletching.

1. For Spin-Wing Vanes® use the 2-sided adhesive tape supplied. For Easton Diamond Vanes no cleaning is required if AAE Fastset™ or any cyanoacrylate adhesive is used. When installing other brands of vanes, wipe the base of the vanes with MEK or lacquer thinner to remove any mold release chemical.

For plastic vanes or feathers, cyanoacrylate adhesives such as Bohning® Instant Super Fletch-Tite, AAE Fastset® or, other instant fletching adhesives give the most secure bond. Saunders N.P.V.® or Bohning Fletch-Tite® cement may also be used. Shafts must be properly cleaned before fletching.

CAUTION:

- a. Cyanoacrylate instant adhesives (Super Glues) bond extremely well to carbon fiber, which can make vanes very difficult to remove without damage to the shaft surface. Easton recommends testing the adhesive on one A/C shaft before fletching an entire set to be sure the surface of the shaft is not damaged when the fletching is removed.
 - b. Some instant adhesives are brittle and can fracture if vanes are hit by another arrow. Loose vanes can drastically affect the flight and grouping of an arrow.
2. Set the rear of the vane 1-1¼" from the bottom of the nock groove.
 3. Attach fletching at an offset to the centerline of the shaft. To assure proper clearance, take into account the type of arrow rest being used. Do not use an angle of offset so great that the farthest right or farthest left corner of the fletching losses contact with the shaft. There should be no open spaces between the shaft and the ends of the base of the vane.

4. Allow cement to fully harden before shooting. Follow manufacturer's instructions for full cure time.

Removing Fletching

CAUTION: Do not soak any carbon shaft in solvents to remove the fletching or fletching adhesive. The solvents will slowly absorb into the shaft and weaken the resin that bonds the carbon fibers.

- 1a. When using instant adhesives, carefully peel off the vanes with a very dull knife and remove most of the glue, being careful not to scrape deep enough to damage the carbon fibers near the surface of the shaft.
- 1b. If you're using standard fletching cements, pull the vanes or feathers off by hand or with pliers.
2. Wipe fletching area with lacquer thinner to remove remaining glue residue. Do a final wipe with 91% isopropyl alcohol.

CAUTION: Keep solvents away from the nock and shaft logo. See the CAUTION about solvents under "Preparing Shafts for Fletching."

3. Let the shafts dry before refletching per the instructions above.

Pulling Carbon Shafts from Target Mats

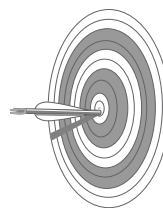

Particles from some target mats may stick on the shaft because of the heat generated during the frictional slowing of these high speed arrows. This frictional bonding may make the shaft difficult to remove from the mat. Several suggestions to help relieve this problem are:

1. Put a coating of hard paste wax or rub a bar of hard soap on the point end of the shaft as needed.
2. Use a cloth impregnated with silicone wax or similar material or use Saunders Friction Fighter® silicone applicator to wipe the lower quarter of the shaft. Be careful not to use too much or too often as the silicone will prevent adhesive from adhering to the shaft if it migrates to the fletching area.
3. Use a piece of natural rubber sheet or a commercially available arrow puller to grip the arrow and make pulling easier.

NOTE: Always pull the arrow straight out of the mat. Make sure no one is behind you when pulling arrows.

Attaching Nocks

See *Installing Nock Systems* later in this guide.



CARBON ICS COMPONENT INSTALLATION

Carbon Beman ICS* Shafts

Some models of Beman's Carbon shafts feature the Internal Component System (ICS). These shafts are made in a larger, more traditional diameter to accommodate internally fitted nocks and points. Even the industry standard RPS threaded points can be used. These shafts provide all of the benefits of carbon's light weight and straightness without the difficulties associated with narrow diameter shafts and externally fitted components. Currently, Beman's large diameter models of carbon shafts are the ICS Hunter and the Beman ICS.

Installing Points and Inserts

EQUIPMENT AND MATERIALS NEEDED FOR INSTALLATION OF POINTS AND INSERTS

- 91% isopropyl alcohol
- paper towels
- cotton swabs
- flexible two-part, 24-hour epoxy (such as AAE epoxy)
- wood toothpick or match stick

Install with Epoxy

Note that the ICS Hunter shaft can be fitted only with ICS Hunter inserts and RPS points. The Beman ICS (target) uses either ACC-60 one piece points or an ACC-60 RPS insert fitted with RPS points.



1. With a cotton tipped applicator (Q-Tip) dipped in 91% isopropyl alcohol, remove the carbon dust from the inside of the tube.
2. Put a small ring of flexible, two-part, 24-hour cure epoxy into the end of the shaft to a depth of 1/4", so it can coat the inside of the shaft as the point is pushed in. A match stick or toothpick may be used. Do not put too much epoxy in the shaft.
3. Evenly coat the exposed insert or point shank with epoxy. If installing an insert, it is easier to handle if an RPS field point is first threaded into the insert.
4. Rotate the shaft while slowly inserting the point or insert into the shaft. Once the point or insert is fully seated, rotate the shaft two more complete revolutions to ensure a thorough covering of epoxy on the point or insert shank and inside the shaft.
5. Wipe off excess adhesive.
6. Stand the shaft with the point up, in an exactly vertical position. This maintains correct alignment of the point and also prevents adhesive from flowing into the threaded portion of the insert. Allow the epoxy to fully cure.

NOTE: Do not use hot melt adhesive on carbon shafts.

* "ICS" refers to all models of Beman shafts featuring an internal component system.

Easton Broadhead Adapter Rings



The Easton Broadhead Adapter Rings were developed for carbon shafts to provide a larger mounting surface when using broadheads with O-ring and other compression-based blade retention systems. The larger mounting surface allows O-rings to compress rather than roll of the top of the small diameter inserts. In addition, the adapter ring provides a smooth, tapered fit from the broadhead ferrule to the insert. Sizes are the same as the A/C/C point/insert sizes. Beman ICS Hunter uses the -60 adapter.

Removing Points and Inserts

Points and inserts installed with epoxy are permanently bonded and cannot be removed.



Fletching ICS Shafts

When preparing for fletching, observe these precautions and instructions:

1. Do not touch cleaned areas with hands or other objects.
2. Fletch as soon as possible after cleaning. If shafts stand unfletched for over 8 hours, repeat the cleaning process.
3. Do not attempt to fletch on very humid days.

Fletching instructions are the same as those used for Easton A/C shafts. For instructions see pages 21-22.

Attaching Nocks

See *Installing Nock Systems* later in this guide.

SAFETY AND HUNTING PRECAUTIONS

Shooting Precautions

WARNING: Carbon shafts should be checked for cracks or other damage before shooting. Although the Beman shaft is the most durable and strongest carbon shaft produced, it is not made with a reinforcing aluminum core (like X10, A/C/E and A/C/C shafts) and is, like any carbon shaft, more susceptible to cracking or breaking if the arrow hits a hard object, or is hit by another arrow. Any carbon shaft should be checked for cracking after each shot.

Procedure

Grip the shaft with one hand near the point and the other hand near the fletching. Rotate the arrow while bending it between the hands. If it feels flexible (rubbery), makes a creaking sound, or rotates strangely, do not shoot the arrow again. It could fracture upon release and cause serious injury to the shooter.

EXTERNAL COMPONENT INSTALLATION

POINTS AND STANDARD ADAPTERS

Some models of carbon Beman shafts utilize a component system that fits over the outside of the shaft. This style of attachment provides protection to the exposed ends of the carbon fiber filaments and adds strength to the shaft. To accommodate this, there are two methods of point attachment.

Beman One-Piece Target Points—These points have an outside diameter which fits over the outside of the shaft to provide protection and strength. In addition, the point shank fits inside the shaft to ensure good alignment.

Beman's Standard Adapter—This attaches over the end of the shaft and provides a threaded fitting for industry standard 8-32 RPS screw-in points or broadheads.

Installing One-Piece Points

EQUIPMENT AND MATERIALS NEEDED FOR INSTALLATION OF ONE-PIECE POINTS

- 91% isopropyl alcohol
- paper towels
- cotton swabs
- flexible two-part, 24-hour epoxy (i.e. AAE epoxy or Beman epoxy)
- wood toothpick or match stick

Installing with Epoxy

Follow the instructions below for a secure and permanent bond:



1. Wipe both the front 1/4" of the shaft and the one-piece point shank with 91% isopropyl alcohol until a clean paper towel shows no residue. Let dry completely before bonding. NOTE: Rubbing alcohol should not be used. It contains oils which could inhibit the adhesive bond.
2. Put a small ring of flexible, two-part, 24-hour cure epoxy into the end of the shaft, so it can coat the inside of the shaft as the point is pushed in. Do not put too much epoxy in the shaft. A thin coat is enough.
3. Thoroughly coat the exposed point shank with epoxy.
4. While rotating the point, slowly insert the point shank into the shaft. Once the point is fully seated, rotate the point two more complete revolutions to ensure a thorough covering of epoxy on the point shank and inside the shaft.
5. Wipe off excess adhesive.

6. Stand the shaft with the point up, in an exactly vertical position. To maintain correct alignment of the point, it must remain vertical and not lean at an angle during the cure time. Allow the epoxy to fully cure.

Removing Target Points

If installed with the recommended epoxy, one-piece points are permanent and cannot be removed without damage to the shaft.

Installing Standard Adapters

EQUIPMENT AND MATERIALS NEEDED FOR INSTALLATION OF STANDARD ADAPTER

- 180 or 240 grit sandpaper
- 91% isopropyl alcohol
- cotton swabs
- flexible, two-part epoxy
- toothpicks or wooden match sticks
- paper towels

Standard Adapters are installed to provide a method of attaching RPS Points and broadheads. Before installing adapters, be sure that the shafts have been properly chamfered if required (see pages 17-18).



1. Lightly sand the surface of the last 5/8" of the point end of the shaft with 180 or 240-grit sandpaper. Precutting the sandpaper into 5/8" wide strips simplifies this step.
2. Wipe the front of the shaft with 91% or higher concentration of isopropyl alcohol (available at most pharmacies) until a clean paper towel shows no sign of residue.

NOTE: Rubbing alcohol should not be used. It contains oils which may inhibit the adhesive bond.
3. Using a cotton swab, wipe the inside surface of the adapter with 91% isopropyl alcohol.

NOTE: Be sure the shaft and components are completely dry before bonding.
4. Thoroughly coat the front 1/4" of the shaft with flexible, two-part, 24-hour cure epoxy such as Arizona Archery Enterprises® epoxy. Do not put epoxy on the end of the shaft because the excess epoxy could be pushed into the threads of the Adapter.
5. Spread a thin film of epoxy on the front 3/8" of the inside surface of the adapter with a toothpick or wood match stick. Be careful not to push epoxy into the threaded section of the outsert.
6. While rotating the outsert, slowly push it over the end of the shaft. Once the outsert is fully seated, rotate the adapter two more complete revolutions to ensure a thorough covering of the shaft and component with epoxy.
7. Wipe off excess adhesive.

8. Check for alignment by rolling the shaft on the wheels of an arrow straightener or on the top of a clean, flat table. If a visible wobble is present, pull the adapter about halfway off and then rotate and push in until fully seated and check again. If the adapter is still crooked, rotate the outsert about one-quarter turn at a time until it is straight.
9. Stand the shaft with the adapter up, in an exactly vertical position. To maintain correct alignment of the adapter, it must remain vertical and not lean at an angle during the cure time. Allow the epoxy to fully cure.

NOTE: Because shaft damage could occur from excess heat, do not use hot melt adhesive.

Removing Standard Adapters

Once installed with the recommended epoxy, Standard Adapters are permanently attached and cannot be removed without damage to the shaft.

CAUTION: Do not soak carbon shafts in any type of solvent to remove components or adhesive residue. The solvents slowly absorb into the shaft and weaken the resin which bonds the carbon fibers.

Preparing Shafts for Fletching



When preparing for fletching, observe these precautions and instructions:

1. Do not touch cleaned areas with hands or other objects.
2. Fletch as soon as possible after cleaning. If shafts stand unfletched for over 8 hours, repeat the cleaning process.
3. Do not attempt to fletch on very humid days.

If you are using Beman G-Nocks (same as Easton A/C/C "G" Nocks) with a Standard Adapter it is best to fletch your arrows with the nocks temporarily installed without adhesive. After fletching, index the nocks properly so that your style of fletching properly clears your arrow rest. If you wish, use an appropriate adhesive to attach your nocks (see pages 27-29).

1. Carefully wipe down just the fletching area of the shaft with 91% isopropyl alcohol using a clean, white paper towel. MEK or lacquer thinner is not used because it is incompatible with the glues used for attaching the Standard Adapter and with the plastic materials used in either style of nock.
2. If using Saunders® or Fletch-Tite® cement to attach your vanes, the fletching area must first be very lightly parallel sanded with 180 or 240-grit sandpaper then cleaned with 91% alcohol.

Fletching Carbon Shafts

EQUIPMENT AND MATERIALS NEEDED FOR FLETCHING

- | | |
|----------------------------------------|-----------------|
| • 180 or 240 grit sandpaper (optional) | • fletching jig |
| • 91% isopropyl alcohol | • paper towels |
| • fletching adhesive | |

The fletching used for the target shafts should be as small as necessary to get good flight and grouping. Fletching for the hunting shafts should be large enough to stabilize the size and weight of the broadhead you use. Remember to always clean the shaft before attaching any style of fletching.

1. For Easton Diamond Vanes, no cleaning is required if AAE Fastset™ or any cyanoacrylate adhesive is used. When installing other brands of vanes, wipe the base of the vanes with MEK or lacquer thinner to remove any mold release chemical.

For plastic vanes or feathers, cyanoacrylate adhesives such as Bohning® Instant Super Fletch-Tite, AAE Fastset®, or other instant fletching adhesives give the most secure bond. Saunders N.P.V.® or Bohning Fletch-Tite® cement may also be used. Shafts must be properly prepared before fletching.

CAUTION: Cyanoacrylate instant adhesives bond extremely well to carbon fiber, which can make vanes very difficult to remove without damage to the shaft surface. Testing the adhesive on one shaft before fletching an entire set is recommended.

2. Set the rear of the vane 1-1/4" from the bottom of the Nock groove. If using a Standard Adapter, set the rear of the vane 1/6 - 1/8" from the end of the adapter.
3. Attach fletching at an offset to the centerline of the shaft. Do not use an angle of offset so great that the farthest right or farthest left corner of the fletching loses contact with the shaft. There should be no open spaces between the shaft and the ends of the base of the vane. To assure proper clearance, take into account the type of arrow rest being used.

Removing Fletching

CAUTION: Do not soak any carbon shaft in solvents to remove the fletching or fletching adhesive. This can weaken the resin that bonds the carbon fibers.

1. When using instant adhesives, carefully peel off the vanes with a knife (not razor sharp) and remove most of the glue, being careful not to scrape deep enough to damage the carbon fibers along the shaft's surface.
2. If using standard fletching cements, pull the vanes or feathers off by hand or with pliers.
3. Wipe fletching area with lacquer thinner to remove any remaining glue residue. Do a final wipe with 91% isopropyl alcohol.

CAUTION: Keep solvents away from both the nock and the shaft logo.

4. Let the shafts dry before refletching.

INSTALLING NOCK SYSTEMS

Nock Styles

There are three types of nocking systems used on Easton and Beman shafts—Taper fit (conventional nock system), Internal fit (includes UNI System and ICS System), External fit (used on some models of Beman Carbon shafts). Because shafts can be fitted with more than one style of nock system, all styles are covered in this one section.

CONVENTIONAL NOCKS

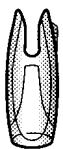

(Taper Fit System)

Conventional nocks (taper-fit) are installed on the aluminum shaft models featuring swaged tapered nock ends.

Attaching Conventional Nocks on the Shaft

Use the following procedure to attach conventional nocks to shafts with a swaged nock taper.

1. If the shaft has been dipped in lacquer or an old nock has been removed, use MEK or lacquer thinner on a clean, white paper towel and wipe the tapered end of the shaft until it is clean and free of old glue or paint. Hold the shaft in one hand and rotate it against the folded paper towel. Repeat this until all lacquer, glue or nock remains have been removed.

CAUTION: Nocks should not be cut off with a knife. Do not sand and do not scrape the shaft's nock taper. Uneven sanding or cutting into the taper by scraping can distort the precision cone shape and can make it difficult for nocks to be attached straight.

2. Apply a large drop of fletching cement to the clean nock taper surface.
3. Spread an even layer of cement around the taper with your finger tip.
4. Quickly, before the cement can dry, press the nock on the taper.
5. Once the nock is on the taper, rotate the nock several times counterclockwise to evenly spread the cement. Then, immediately rotate the nock clockwise (using a light downward pressure) until the nock groove is properly positioned and the nock is firmly seated on the taper.
6. Carefully wipe excess cement from the nock base. Check the nock for straightness and allow it to set at least two hours before shooting.

Removing Broken Conventional Nocks



1. Heat the conventional nock over a small flame.
2. When the nock starts to soften, gently grip the softened plastic with a pair of pliers and twist off.
3. Clean the nock swage (or UNI Extension) by wiping the taper with a clean cloth soaked in lacquer thinner until it is clean of all nock and glue residue.

CAUTION: Nocks should not be cut off with a knife. Do not sand and do not scrape the shaft nock taper. Cutting into the taper or distorting the precision cone shape by uneven sanding or scraping can make it difficult for nocks to be attached straight.

UNISYSTEM

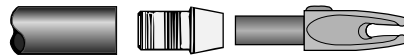

Universal Nock Installation (UNI) System (Internal Fit)

Aluminum shafts sizes smaller than 2012, as well as most sizes of A/C/C shafts, use the Standard UNI Bushing which has an inside diameter sized to fit A/C/E "G" Series nocks. Aluminum shaft sizes 2012 and larger use the Super UNI Bushing. This has a larger inside diameter which fits the Super Nock and the 3-D Super Nock. A/C/E shafts all have the same inside diameter as that of a Standard UNI Bushing, as does the -00 size A/C/C shaft, so no adapter is required. A nock can be inserted directly into the shaft.

Installing Carbon UNI Bushings



Carbon UNI Bushings should be installed with 24-hour flexible epoxy. Installation of Carbon UNI Bushings is similar to the installation of carbon composite inserts described on page 19.

The pencil technique for holding the bushing during installation, as illustrated on the following page, may also be used, but do not attempt to use hot melt. Use only flexible epoxy on carbon composite components.

Removing Carbon UNI Bushings

1. To remove the bushing, select an Allen wrench that is slightly larger than the hole diameter. Heat the wrench over a flame until hot enough to melt into the bushing. Push it into the hole in the bushing and let it cool.
2. Lightly heat the end of the shaft for 3-5 seconds over a small gas flame.
3. Grasp the wrench with pliers and rotate to break the bushing free.
4. Repeat steps 2 and 3 until the adhesive bond is destroyed by the heat and the insert pulls free. Remember, excess heat will destroy the shaft.

Installing Aluminum UNI Bushings

EQUIPMENT AND MATERIALS NEEDED FOR INSTALLATION OF UNI OR SUPER UNI BUSHINGS

- 91% isopropyl alcohol
- paper towels
- cotton swabs
- Easton hot-melt
- torch or gas burner
- pencil for "holding tool"

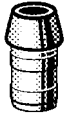

1. Lightly chamfer the inside of the core tube as described previously in the cutting instructions.
2. Clean inside the nock end of the shaft approximately one inch using a cotton swab dipped in 91% alcohol. Repeat the process until a fresh cotton swab is free of residue or cutting dust. Let the shaft dry thoroughly before bonding.
3. Heat a stick of Easton's hot-melt adhesive over a small gas flame; apply a ring of adhesive inside of the shaft.
4. Twist the bushing onto the end of a sharpened wooden pencil (see illustration below).
5. Using the pencil as a UNI Bushing "holding tool," heat the bushing just enough to apply a thin coating of hot-melt adhesive on the shank.

CAUTION: If the wood pencil chars, the bushing is overheated.

6. Lightly reheat the bushing to melt the adhesive and quickly insert it completely into the shaft.
7. Quickly wipe off excess adhesive, then remove the pencil after the adhesive has solidified.

CAUTION: Do not apply a flame directly to any Carbon or Aluminum Carbon shaft.

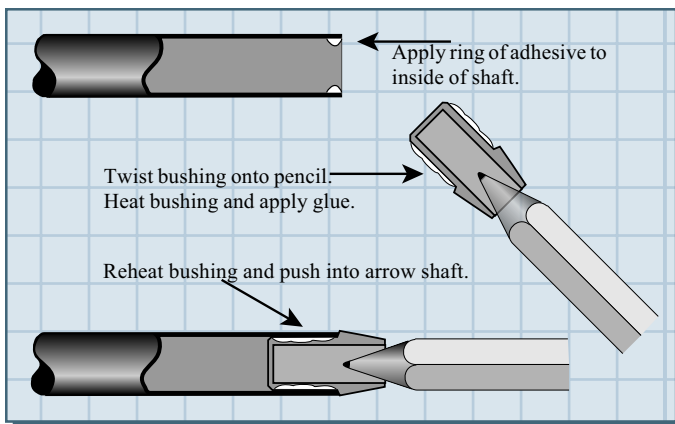

Instant-Set Glue Method

Some brands of quick setting glues are made to remain flexible after curing. These glues can be used to bond UNI Bushing to shafts. Bohning Instant Super Fletch Tight II™ and AAE Fastset Gel™ are two such glues.

To glue, spread a thin film of glue on the bushing. Start the bushing into the end of the shaft, then quickly push the end of the shaft against a wooden bench or block of wood. The insert must be pushed into the shaft quickly with a single stroke, before the glue can set up.

Installing A/C/E "G" Nocks, X10 Nocks, and Super Nocks

(Directly into Shafts or UNI Bushings)



X10, A/C/E "G" Nocks, and Super Nocks are designed to be installed and shot without adhesive. If you prefer to use an adhesive, use a light removable glue such as Carter's® rubber cement (for gluing paper) or FaberCastell® Glue Stick. Certain adhesives contain solvents that attack the polycarbonate nock material. When this occurs, the nock becomes brittle and can break when shot. Do not use typical fletching cements which usually contain M.E.K. (Methyl Ethyl Ketone), toluene, acetone, or lacquer thinner. To determine if you are using a compatible adhesive, use the compatibility test described at the end of the Nock Installation section.

Installing without Glue

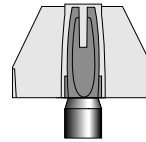

Super Nock Tool

1. Push the nock into the shaft by hand or with a nock tool.
2. Rotate the nock while inserting it into the shaft.

NOTE: Do not attempt to rotate the nock by inserting a coin or other instrument between the ears of the nock.

NOTE: A tighter fit is used with Super Nocks because of their use as a hunting nock. As a result, a nock installation tool is necessary when installing Super Nocks. See your dealer for Easton's Super Nock Tool.

Installing A/C/E and Super Nocks with Rubber Cement

1. Put a thin coat of Carter's rubber cement or FaberCastell glue stick on the shank of the nock.
2. Slowly insert the nock into the UNI or Super UNI Bushing while rotating the nock.
3. Immediately remove the nock and let it air dry for 5-10 seconds.
4. Reinsert the nock into the bushing.
5. Rotate to get proper nock alignment if shafts are fletched.

Alternate Procedure Using Cyanoacrylate Adhesive

1. Slip the nock into the shaft until there is approximately 3/16" (5 mm) remaining before the nock is fully seated.
2. Place a very thin layer of instant adhesive around the exposed area. (Do not cover entire shank as it will make removal difficult.) Properly align the nock with the fletching before fully seating the nock.

CAUTION: This adhesive bonds very quickly.

3. Push the nock straight in, without turning, until seated.
4. Hold for five seconds or until the adhesive sets.

Alternate Procedure Using Thin Plastic Film

Another method for installing A/C/E and Super Nocks into UNI and Super UNI Bushings is to use a very thin plastic film such as plastic food shopping bags, dry cleaning bags, etc. The film provides an effective method for securing the nock in the shaft and also allows easy removal.

1. Place a small piece (3/4" circle) of the plastic film over the end of the nock to be inserted into the bushing.
2. Gently push the nock to get it started into the bushing.
3. Push and twist the nock until it is fully seated against the bushing.
4. Remove any excess plastic film from around the nock with thumb and finger nail.

If the shank of the nock punches through the plastic rather than stretching it into the gap between the nock shank and shaft, try a thinner plastic or put a slight chamfer on the end of the nock shank.

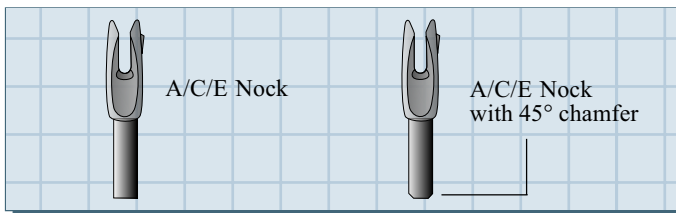

To chamfer the end of the shank, simply hold the nock at the top and pull the nock shank at a 45° angle across a flat sheet of sandpaper, or along a fine file, while rotating the nock. This procedure will allow the nock to “grip” the plastic rather than punching a hole through it.

Removing Broken A/C/E Nocks & Super Nocks



Pliers

Gripping the nock with a pair of pliers, twist and pull until the adhesive bond, if any, has loosened and the nock pulls free.

Multi Nock Tool

If the nock is broken off flush with the bushing or shaft end, use Easton’s Multi-Nock Tool with Extractor. To remove, thread the tool down through the broken nock into the hollow core of the nock shank as shown in the illustration, and pull the nock out.

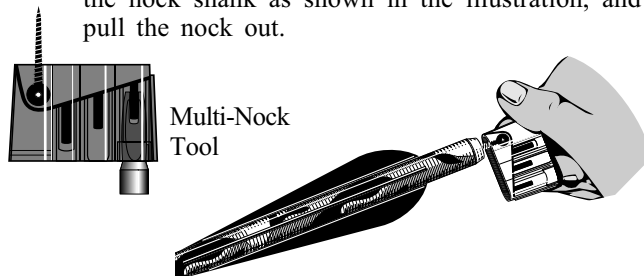

Screw or Cup Hook Method

If a Multi Nock Tool is not available, use this method to remove a nock that has broken off flush with the bushing.

1. Twist a small screw or a cup holder into the hollow core of the nock shank.
2. Pull the screw out with pliers to remove the nock shank.

Allen Wrench Method

A/C/E nocks made prior to 1995 did not have a hollow core in the shank. To remove a pre-1995 A/C/E nock that has broken off flush with the bushing, use the following method.

1. Grip a small Allen wrench with pliers and heat it until it is hot enough to melt into the shank of the nock.
2. Push the heated Allen wrench into the broken nock shank.
3. After the nock shank cools and solidifies on the Allen wrench, twist the Allen wrench with pliers to break nock shank loose, then pull out.

BEMAN OVERNOCKS

(External Nocks)

Some Beman carbon shafts require nock systems that fit over the outside of the shaft. Beman provides two ways to accomplish this: The Beman Overnock, which fits over the end of the shaft, and the Nock Outsert, which is an adapter that fits over the end of the shaft and allows an Easton A/C/E “G” nock to be used.

Installing Beman Overnocks



Overnocks can be installed either without adhesive or with Carter’s® rubber cement or FaberCastell® glue stick. Do not use typical fletching cements which usually contain solvents incompatible with polycarbonate nocks. To be sure you are using a compatible adhesive, select adhesives that are recommended for A/C/E or Super Nocks or that have passed the compatibility test described on page 30.

1. If desired, apply a thin layer of compatible adhesive to the last 1/2" of the nock end of the shaft.
2. Slowly push the nock on the shaft while rotating one full turn.
3. Check the nock for straightness by rolling on the wheels of an arrow straightener or on a clean, flat surface. If the nock is not straight, rotate the nock and check it. Repeat this process until the nock is straight.

Removing Overnocks

1. Lightly grip the body of the nock with pliers and twist off.
2. If pliers don’t work, cut the nock off with a dull knife, being careful not to cut into the shaft surface.
3. Clean off any nock or adhesive residue with a dull knife. Do not cut into the carbon material. Wipe shaft well with 91% isopropyl alcohol before rebonding another nock.

Installing Nock Outserts

EQUIPMENT AND MATERIALS NEEDED FOR INSTALLATION OF NOCK OUTSERTS

- 180 or 240 grit sandpaper
- 91% isopropyl alcohol
- paper towels
- cotton swabs
- flexible, two-part epoxy or cyanoacrylate adhesive
- toothpicks or wooden match sticks



Follow the instructions for installing Standard Adapters on page 25, however, only sand the shaft 1/2" from the nock end. Cyanoacrylate adhesives such as Bohning® Instant Super Fletch-Tite, AAE Fastset®, Loctite® 454 (or Super Glue®) can also be used to install Nock Outserts. These adhesives bond very quickly and only a small amount of adhesive is required.

Removing Nock Outserts

If installed with the recommended epoxy, these outserts are permanent and cannot be removed without damage to the shaft.

Installing G-Nocks in Nock Outserts



G-Nocks (A/C/E "G" Nocks) have a precision, snug fit in the outsert and a uniform fit on the string. For Target or Field shooting, they can be shot without adhesive or with a low-strength adhesive that will ensure that the nocks do not rotate. If you prefer to use an adhesive, you should use a light removable adhesive like Carter's® rubber cement (for gluing paper) or FaberCastell® Glue Stick (or an adhesive that contains Naphtha and/or Hexane).

CAUTION: Do not use typical fletching cements that usually contain M.E.K. (Methyl Ethyl Ketone), toluene, acetone, or lacquer thinner on A/C/E Nocks, Overnocks or Nock Outserts. Certain adhesives contain solvents that attack polycarbonate nocks. When this occurs, nocks become brittle and can break when shot. To be sure you are using a compatible glue, use the adhesive compatibility test on page 30.

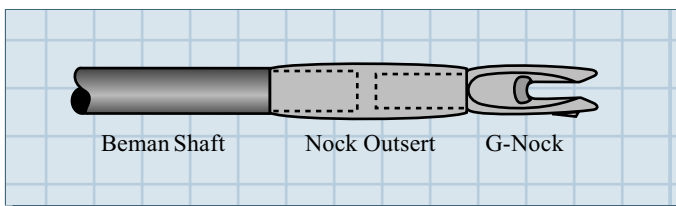

Procedure

1. Apply a thin coat of the Carter's® rubber cement or FaberCastell® glue stick or other compatible adhesive on the shank of the nock.
2. Slowly insert the nock into the outsert while rotating the nock.
3. Rotate to get proper nock alignment.

Removing Broken A/C/E Nocks

See methods described on previous page.

Adhesives for Nocks, Nock Outserts, and UNI or Super UNI Bushings

The following chart lists the components that make up the nock systems, and suggests glues that may be used for each. The installation procedures for each of the components are covered in the accompanying text.

ADHESIVES FOR NOCK SYSTEM COMPONENTS	
COMPONENT	ADHESIVE FOR INSTALLATION
UNI Bushing or Super UNI Bushing	Aluminum Shafts—Easton Hot Melt A/C* Shafts—Easton Hot Melt, 24-hour Epoxy, or flexible cyanoacrylates
Carbon UNI Bushing or Carbon Insert	Use 24-hour flexible epoxy or flexible cyanoacrylates (Bohning or AAE)
A/C/E Nock, Super Nock, or 3-D Super Nock	Can be installed without adhesive, or with Carter's® rubber cement, FaberCastell® Glue Stick, flexible cyanoacrylate adhesive (Bohning or AAE), or Thin plastic film
Conventional Nock:	Saunders NPV®, Fletch-Tite® Flex Bond®
Overnock	Can be installed without adhesive, or with Carter's® rubber cement, FaberCastell® Glue Stick, or similar glues.
Nock Outsert Standard Adapter	Use 24-hour flexible epoxy or cyanoacrylate

* "A/C" Shaft refers to all models of aluminum/carbon shafts. Current models are X10, A/C/E, A/C/C, and HyperSpeed.

Checking Conventional Nock Straightness

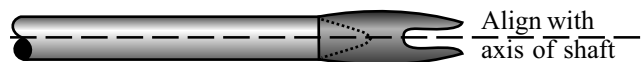

1. Rest the shaft on the nails of your thumb and index finger (with the point against the palm of your other hand) and blow against the fletching. As the arrow spins, observe the nock rotation. A straight nock will spin without any wobble.
2. Roll the shaft on an arrow shaft straightener or a flat, smooth surface and watch for any nock wobble.
3. Use commercially available nock checking tools such as the Björn Bengtson nock alignment jig.

If the nock is crooked, before the cement sets twist and press the nock on the taper and check again. If it is still crooked, remove the nock, clean the taper and install another nock.

ADDITIONAL INFORMATION

Adhesive Compatibility Test

Here is a simple test to determine if the nock adhesive you wish to use is compatible with the various nock materials.

1. Choose a nock as a test sample.
2. Apply a small amount of the adhesive you intend to use on the nock shank and spread the adhesive evenly around the shank.
3. Let the nock set for approximately ten minutes.
4. Grip the nock with a pair of pliers at the top portion of the nock (the part that fits outside the arrow). See the illustration below.
5. Press the nock shank against a flat table surface and try to bend the nock shank to a 45° angle.
6. If the nock shank will bend without breaking, as shown in the illustration below, then the adhesive is compatible with the nock. If the nock shank breaks, do not use the adhesive.

1. Spread adhesive to be tested on shank of nock:
2. Wait 10 minutes. Then Grip the nock with pliers.

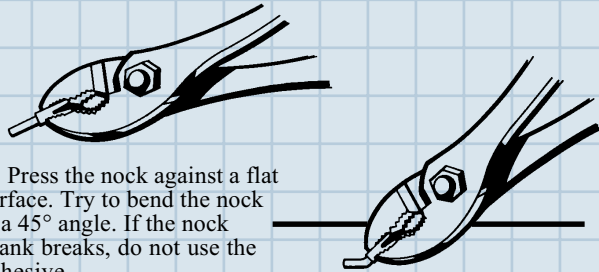

3. Press the nock against a flat surface. Try to bend the nock at a 45° angle. If the nock shank breaks, do not use the adhesive.

Securing Screw-in Points

Due to the impact of the arrow, points may get loose during shooting. Grip the point with pliers and grip the shaft with a rubber shaft gripper to tighten the point. An alternate method is to screw in the points with a small dab of Easton hot melt adhesive.

Shooting Precautions

(All Types of Carbon Arrows)

WARNING: Check all carbon shafts for cracks or other damage before shooting. Although Beman shafts are the most durable and strongest carbon shafts produced, they are not made with a reinforcing aluminum core (like X10, A/C/E and A/C/C shafts). As a result, any carbon shaft is more susceptible to cracking or breaking if the arrow hits a hard object or is hit by another arrow. All styles of carbon shafts should be checked for cracking after each shot.

Procedure

Grip the shaft with one hand near the point and the other near the fletching. Rotate the arrow while bending it between the hands. If it feels flexible (rubbery), makes a creaking sound, or rotates strangely, do not shoot the arrow again.

Any carbon arrow that has cracked and is more flexible when twisted than a new arrow, could fracture upon release of the string (especially when shot from a high-energy compound bow) and seriously injure the shooter.

Hunting Precautions

There is always a possibility that an arrow shaft used in bowhunting will break after being shot into a big-game animal. If a carbon arrow breaks, it tends to shatter and produce many sharp, splinter-like carbon fragments. These fragments could be harmful if ingested, so when game is recovered, the hunter should always carefully determine whether the arrow has broken inside the animal. If the arrow has broken, follow the instructions below:

1. Use extreme caution when removing broken segments of the carbon arrow shaft.
2. When field dressing game animals, use care to avoid splinters of carbon fiber.
3. Carefully remove the flesh in the area of the wounds. It may contain carbon fibers, particularly at the entry and exit points.
4. Thoroughly clean the surrounding area of the wound and inspect for carbon fragments.
5. Carefully dispose of any meat that might contain carbon splinters.

MORE GREAT TECHNICAL STUFF FROM EASTON

SLOW MOTION VIDEO—Watch arrows fly in super slow motion. Shot at an incredible 7,000 frames per second, you can see the answers to all your questions about arrow rests, fingers vs. mechanical release, vanes vs. feathers, etc.

COMPUTER PROGRAMS—Easton's Shaft Selector "Plus" lets you go through Easton's Selection Charts at electronic speed. Easton's Arrow Flight Simulator lets you try new setups with computer simulations. Over 99% accurate! You can find your bow's best arrow match, find the fastest setup to meet each set of tournament rules, or try out a new set of arrow shafts to use with your favorite broadheads. All without going to the range!

ARCHER'S ALMANAC—The most complete archery reference manual available. Everything from how-to and where-to information from the nation's top archers to in-depth detail about equipment specifications, graphics that reveal your own arrow trajectory, charts that show changes in velocity as bow weight changes, and lots more!

For more information call or write Easton. The address and phone number are on the back page of this manual.

Minimum Recommended Arrow Weight

At the request of the bow manufacturers, AMO developed the Minimum Recommended Arrow Weight chart because breakage of high-energy bows has resulted from using arrows that are too light. The recommended minimum arrow weights were determined from tests performed on various brands of bows with cast metal risers. After determining the safe amount of energy left in the bow (23-28 ft./lbs.) when a 360-grain arrow is shot from a 60# speed cam compound bow at a 30" AMO Draw Length, the arrow weights for all other draw lengths and bow weights were calculated using this safe "retained energy" figure. Using arrow weights equal to or heavier than those recommended will reduce the possibility of

damage to and/or breakage of bows and therefore help prevent injury to archers.

Bows with machined risers have become popular since this testing was performed. Due to their added strength, they may be able to shoot lighter arrows. How much lighter, if any, has not yet been determined.

Using the Minimum Recommended Arrow Weight chart

- Select the column that describes the type of bow you shoot.
- Move down that column to locate the bow weight range that includes your Peak Bow Weight.
- Move horizontally across that row to your "AMO Draw Length" column.
- The box at that location contains the minimum total arrow weight¹ recommended for your equipment.

IMPORTANT: The lengths shown in the chart below are "Draw Lengths," not arrow lengths.

ACTUAL PEAK BOW WEIGHT (LBS.)				AMO MINIMUM RECOMMENDED ARROW WEIGHTS ¹ (GRAINS)																					
RECURVE	ROUND WHEEL	ENERGY WHEEL (Soft Cam)	SPEED CAM (Hard Cam)																						
S.E.* = .95 P.D.F.* = .95 E.S.E. 62 B.H. 9.5	S.E.* = 1.04 P.D.F.* = 1.04 E.S.E. 65.6 B.H. 9.0	S.E.* = 1.20 P.D.F.* = 1.20 E.S.E. 71.3 B.H. 8.0	S.E.* = 1.3+ P.D.F.* = 1.3+ E.S.E. 75.1 B.H. 7.0	AMO DRAW LENGTH **																					
				25"	26"	27"	28"	29"	30"	31"	32"	33"													
33	32	29	27	150	150	150	150	150	150	150	150	150	150	150	150	150	150	150	150	150	150	150	150	150	
34-41	33-38	30-35	28-32	150	150	150	150	150	150	150	150	151	165												
42-46	39-43	36-39	33-36	150	150	150	150	150	163	179	195	211													
47-52	44-49	40-44	37-41	150	150	150	167	185	203	222	240	258													
53-58	50-54	45-49	42-46	150	163	183	203	224	244	264	285	305													
59-63	55-60	50-54	47-50	172	195	217	240	262	284	307	329	352													
64-69	61-64	55-59	51-55	202	227	251	276	300	325	350	374	399													
70-75	65-71	60-64	56-60	232	259	286	312	339	365	392	419	445													
76-81	72-76	65-70	61-65	262	291	320	348	377	406	435	463	492													
82-86	77-81	71-74	66-69	292	323	354	385	416	446	477	508	539													
87-92	82-87	75-79	70-74	322	355	388	421	454	487	520	553	586													
93-99	88-94	80-85	75-80	352	387	422	457	492	532	581	629	676													

¹ Arrow weight includes all arrow components—shaft, insert, point, fletching and nock.
^{*} Based on: • 360 Grain Arrow • 30" Draw Length • 60# Peak Weight • Speed Cam
 S.E. = Stored Energy, P.D.F. = Peak Draw Force,
 E.S.E. = Energy Storage Efficiency, B.H. = Brace Height,

**Draw Length

NOTE: AMO Draw Length is not necessarily the same as your Correct Arrow Length. AMO Draw Length equals the distance from the bottom of the nock groove to the pivot point of the grip + 1 3/4" while at full draw position. This distance is approximately the distance from the bottom of the nock groove to the far side of the bow. Correct Arrow Length is measured from the nock groove to the end of the shaft. If you draw the end of the arrow flush with the far side of your bow, arrow length and draw length are approximately the same. If the end

of your arrow is in front of the far side of your bow, or if you pull the end of your arrow inside the far side of your bow or use an overdraw, Draw Length and Correct Arrow Length will not be the same. You must use AMO Draw Length when using the AMO Minimum Recommended Arrow Weight chart above as this AMO Draw length determines the energy your bow has stored at full draw. Use Correct Arrow Length when using the Easton Shaft Size Selection charts.

F.O.C. (Front of Center)

The term F.O.C. (Front of Center) describes the percentage of the arrow's total weight that is located in the front half of the arrow. The more weight that is located in the front half of the arrow, the more forward is the center of balance of the arrow. Why is this important? It is generally believed that the F.O.C. balance position of the arrow is one of the more important elements affecting the shape of the arrow's trajectory curve.

Unfortunately there are too many variables affecting the path of an arrow to make it possible to precalculate the trajectory of an arrow simply by controlling its F.O.C.. Some archers, though, find it valuable to determine and record the F.O.C. of their arrows once they have achieved the flight characteristics they desire.

The importance of F.O.C. is greatest in archery events that emphasize long range shooting. FITA archery (Olympic Style) which requires archers to shoot up to 90 meters is the best example of this.

In short range events, such as indoor archery, the effect of F.O.C. is not significant. Other factors affecting arrow flight are more important to these archers.

Changes in the trajectory of an arrow, for whatever reason, are quite apparent in archery events or bowhunting conditions that call for shots to be made at both short and long ranges. Bows for these situations usually include the use of multiple sight pins or multiple premarked sight settings. Since changing the F.O.C. of an arrow may change the shape of its trajectory, it may also change the preset sight locations on the bow sight.

F.O.C. Guidelines

The balance of an arrow can be modified by adding weight to either the front or the rear of the shaft. Heavier vanes, for example, increase the weight of the rear

portion of the arrow. Replacing vanes with feathers lightens the rear of the arrow. Various points, inserts, and even added weights are used to modify the weight of the front of the arrow.

Even though there is no established perfect F.O.C. for each setup, there are some general recommendations that provide a good starting point when either constructing a set of arrows or when analyzing an arrow's flight characteristics.

F.O.C. Recommendations

Aluminum Target Arrows	7-9 %
A/C/C Target Arrows	9-11 %
A/C/E Target Arrows	11-16 %
Hunting Arrows	10-15 %

Use the following formula to calculate the exact F.O.C. of an arrow.

Determining F.O.C. %

AMO-Standard F.O.C. balance formula

$$F.O.C. \% = \frac{100 \times (A-L/2)}{L}$$

L = Correct Arrow Length—Distance from bottom of nock groove to end of shaft

A = Distance from bottom of nock groove to finished arrow balance position (includes weight of point [+ insert], nock system and fletching)

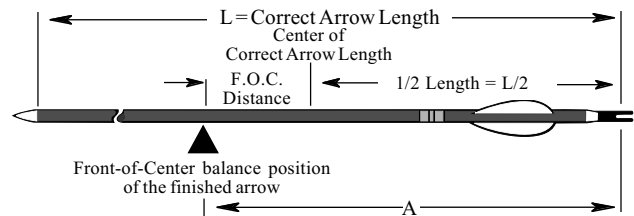

5040 W. HAROLD GATTY DR. SALT LAKE CITY, UT
84116-2897 U.S.A. (801) 539-1400 FAX (801) 533-9907

Rev. 4, 4/99
Printed on Recycled Paper

